

DuraForce EX

KY-51D

INSTRUCTION MANUAL

Introduction

Thank you for purchasing "KY-51D".

Be sure to read this manual before and during use to ensure proper operation.

Instruction Manual

"Quick Start Guide" (bundled accessory) (in Japanese only)

This manual describes part names and functions.

"Instruction Manual" app (eトリエツ (e-manual)) (handset app) (in Japanese only)

This manual describes detailed guidance and operations of functions.

Enter words freely to search the handset, open settings and apps directly from a current page, etc. to use the handset more conveniently.



[Using this instruction manual]

In the home screen, [田] ▶ [Instruction Manual]

* Before using it for the first time, follow the instructions on the screen to download and install the app.

* You can also access the "Instruction Manual" (e-manual) from "my daiz".



"Wi-Fi" no tsukaikata

"Wi-Fi" wo setsumeisho apuri de shirabemasu.



"Instruction Manual" (in PDF format)

This manual describes detailed guidance and operations of functions.

Download from the NTT DOCOMO website.

NOTE

- "KY-51D" is referred to as "handset" in this manual.
- The explanations in this manual are based on the handset at time of purchase.
- Handset is subject to version updates of the operating system (OS) to enhance quality and functionality. These may change how to operate handset. For details on added functions and changes to operation, refer to the NTT DOCOMO website. Older versions of apps may no longer be usable, or unintended issues may occur.

- Accessible apps and services may be limited by the conditions of your subscription contract. For details, refer to the NTT DOCOMO website.
- Descriptions are for the Home app set to "docomo LIVE UX".
- The contents of this manual as well as the website URL are subject to change without prior notice.
- The screens and illustrations in this manual are shown as examples. Actual screens and illustrations may differ.
- Reproduction of this manual in part or in whole without prior permission is prohibited.

Handset and bundled accessories

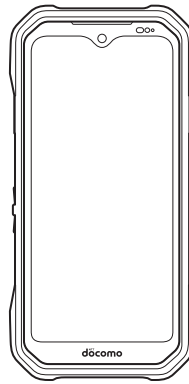

KY-51D

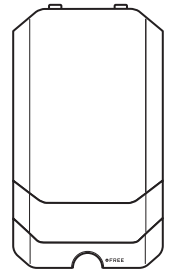

Back cover
KY04<K>

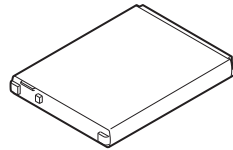

Battery pack KY02

- Quick Start Guide (in Japanese only)
- You can also check and purchase optional accessories (sold separately) compatible with the handset at the NTT DOCOMO Online Shop. <https://onlineshop.smt.docomo.ne.jp/options/search.html> (in Japanese only)

Contents

Instruction Manual	H2
--------------------------	----

Important

Using the handset	3
Recommended functions	3
Precautions (ALWAYS FOLLOW THESE DIRECTIONS)	4
Handling precautions	9
Water, Dust, & Shock Resistance	12
Caring for the handset	14

Preparing to Use the Handset

Part names and functions	18
Battery pack	19
SIM	21
microSD card	22
Charging	24
Powering on/off	25
Initial settings	26
Security codes used on the handset	27

Basic Operations

Basic operations	29
Character entry	32
Notification LED	33
Screen display and icons	34
Task manager	35
Multiwindow	35

Home Screen

Switching the Home app	36
docomo LIVE UX	36
App list screen	37
Simple home	38
App list	38

Phone/Contacts

Making a call	40
Answering a call	41
Operations during a call	41
Call histories	42
Auto answer	42
Call settings	43
Contacts	44

Mail/Web Browser

docomo mail	46
+Message	46
Gmail	48
Early Warning "Area Mail"	48
Web browser	49

Camera/Gallery

Camera	51
Barcode scanner	53
Photos	54

Apps

dmenu	55
Play Store	55
Osaifu-Keitai	55
Radio	57
Location services	57
Clock	58
Schedule	59
Memo	60
Calculator	60
docomo Data Copy	60

Handset Settings

Settings menu	62
Network & internet	62
Connected devices	65
Apps	65
Notifications	66
Battery	66
Storage	67
Sound & vibration	67
Display	68
Wallpaper & Style	68
Accessibility	68
Security	69
Privacy	72
Location	72
Safety & emergency	72
docomo service/cloud	73
Passwords & accounts	73
Digital Wellbeing & parental controls	74
Google	74
System	74
About phone	75

Managing Files

Memory storage	76
Working with files	76

Data Transfer

Bluetooth® transfer	77
NFC communication	78

Connecting with External Devices

PC connection	79
---------------------	----

International Roaming

About International Roaming (WORLD WING).....	80
Services available overseas	80
Before using the handset overseas	80
Making/receiving calls in your country of stay	81
International roaming settings	82
Things to check after returning	83

Appendix

Troubleshooting (FAQ).....	84
Software update	87
Warranty & after-sales service	88
Main specifications.....	90
Certification and compliance.....	90
Specific Absorption Rate (SAR) Information of Mobile Phones	90
FCC Notice.....	91
Export control regulations.....	92
Intellectual property rights.....	92
Index	94

Important

Using the handset

- The handset is not SIM-locked, and supports 5G, LTE, W-CDMA, GSM/GPRS, and wireless LAN systems.
- Because the handset relies on radio signals, it cannot be used in a place with no signal (such as tunnels, underground or in buildings), in places with a weak signal or outside the 5G service area or LTE service area. You may not use the handset in the upper floors of a building even with no obstructions in sight. There may also be times when the signal is strong with the signal status icon  is displayed and you are not moving but the call is interrupted.
- Since the 5G, LTE, W-CDMA, and GSM/GPRS systems automatically apply a private call feature to every call, a third party that tries to listen in only hears noise.
- The handset converts conversations into a digital signal and sends it to the other party over the radio. If the signal cannot be reconverted properly by such as moving to an area with a weak signal, the voice may not be heard correctly.
- Note that simultaneous use of the nano SIM card and an eSIM may cause services or functions that you use to be restricted.
- Take notes of data stored on the handset or save the data to external memory devices such as microSD cards and PCs periodically. DOCOMO shall not be liable whatsoever for any loss of content due to a failure, repair, model change or other handling of the handset.
- Be sure you check providers and operating conditions of any apps or sites you are going to use. Handset operation may become unstable, or your location or personal information may be transmitted via the Internet and use inappropriately, depending on apps you may install or sites you may visit.
- The handset automatically performs communication for some functions, for example, to synchronize data, check the latest software version or maintain connection with the server. Also, large-volume data communication such as downloading apps or watching videos will lead to higher packet communication charges.
- During initial settings, apps provided by DOCOMO may be installed automatically. This may incur packet transmission fees if the mobile network is used. Apps are automatically selected based on our assessment of customer needs using information you have agreed to provide to DOCOMO and other information that DOCOMO possesses. Handling of customer information is managed appropriately according to DOCOMO's privacy policy.
- Depending on the apps or services you are using, packet communication charges may be incurred even while using Wi-Fi.
- Activated applications may stop functioning properly if free space on microSD card or the handset is inadequate. In this case, delete saved data.

- Ensure the security of your handset by setting a screen lock password in case you lose it (→P.70).
- If the handset is lost, use a computer to change passwords and disable authentication so as to prevent use of Google services (such as Gmail and Google Play), SNS, and other service accounts.
- Check terms of usage as established by Google and each provider in using third-party-provided services and apps including those provided by Google LLC. DOCOMO is not responsible whatsoever for any issues arising from docomo services or apps.
- If terms of use appear, follow the instructions on the screen.
- Apps and their service contents are subject to change without prior notice.
- For details on usage fee, refer to the NTT DOCOMO website.
- The display is manufactured using high-precision technology, but it may contain dots that fail to light or that remain permanently lit on some areas. This is a characteristic of the display and not a malfunction.
- DOCOMO shall not guarantee operation of commercially available optional accessories.

Recommended functions

Battery swap function

Swap the battery pack while the handset is powered on (→P.20).

Direct keys

A direct key is located on both sides of the handset. Assign often-used apps for quick access (→P.30).

Barcode Scanner

An app for scanning barcodes is installed allowing smooth scanning and checking of barcodes and QR codes (→P.53).

ø3.5 earphone jack (earphone mic terminal)

The handset has a ø3.5 earphone jack. Connect headphones, earphone mic, etc. quickly (→P.18).

Wet touch / glove touch mode

Glove touch mode enables wet touch operation with wet hands, as well as touch operation while wearing heavy gloves such as at a construction site (→P.68).

Record later



After ending a call, save the conversation as voice data.

You can listen again after the call (→P.44).

For details, see the Kyocera Corporation website (<https://www.kyocera.co.jp/prdct/telecom/office/phone/lineup/ky-51d/>) (in Japanese only).





Precautions (ALWAYS FOLLOW THESE DIRECTIONS)

- Before use, read these "Precautions" carefully and use your handset properly.
- These precautions contain information intended to prevent bodily injury to the user and to surrounding people, as well as damage to property, and must be observed at all times.
- The following signs indicate the different degrees of injury or damage that may occur if information provided is not observed and the handset is used improperly.

 DANGER	This sign denotes that "death or serious injury (*1) may directly result from improper use".
 WARNING	This sign denotes that "death or serious injury (*1) may result from improper use".
 CAUTION	This sign denotes that "minor injury (*2) or damage to property (*3) may result from improper use".

- *1 Serious injury: This refers to loss of sight, injury, burns (high- and low-temperature), electric shock, broken bones, poisoning, etc. with remaining aftereffects, and injuries requiring hospital admission or long-term hospital visitation.
- *2 Minor injury: This refers to injuries, burns (high- and low-temperature), electric shock, etc. that do not require hospital admission or long-term hospital visitation.
- *3 Damage to property: This refers to extended damage to buildings, furniture, livestock, pets, etc.

- The following symbols indicate specific directions.

 Don't	Prohibited actions.
 No disassembly	Denotes not to disassemble.
 No liquids	Denotes not to use where it could get wet.
 No wet hands	Denotes not to use with wet hands.
 Instruction	Denotes mandatory instructions (matters that must be complied with).



Unplug

Denotes that the equipment should be unplugged.

1. Handling the handset, battery pack, adapters, and nano SIM card (common)



Don't

Do not use, store or leave the equipment in locations subject to high temperatures or where heat collects (near a fire or heating unit, in a kotatsu or futon, under direct sunlight, inside a vehicle on a hot day, etc.). May cause fire, burns, injury, electric shock, etc.



Don't

Do not place the equipment inside or near cooking appliances such as microwave ovens, IH cooktops, or pressure cookers. May cause fire, burns, injury, electric shock, etc.



Don't

Do not expose to or place directly on sand, dirt, or mud. Do not handle with dirty hands. May cause fire, burns, injury, electric shock, etc. Refer to the following for details on water/dust resistance.
→P.12 "Water, Dust, & Shock Resistance"



Don't

Do not charge the equipment when wet with water or other liquid (beverage, sweat, seawater, pet urine, etc.).
Do not charge where exposed to water (bathroom, near a humidifier, etc.).
May cause fire, burns, injury, electric shock, etc. Refer to the following for details on water resistance.
→P.12 "Water, Dust, & Shock Resistance"



Don't

Do not subject the handset to strong pressure or break the handset. Especially when carrying it in your pocket, do not hit it or press it between other objects.

Internal battery or battery pack breakage may cause fire, burns, injury, etc.

* Examples to avoid

- Sitting or squatting with handset in your pants or skirt pocket
- Handset becoming caught in a sliding door or vehicle door when in a jacket pocket
- Stepping on handset when it is on something soft such as a sofa, bed, or futon or on the floor
- Handset becoming caught in a seat on a train or bus



Don't

Do not try to remove the internal battery. May cause fire, burns, injury, electric shock, etc.





No disassembly

Do not attempt to disassemble or modify the equipment.

May cause fire, burns, injury, electric shock, etc.

 **No liquids** Do not get the equipment wet with water or other liquid (beverage, sweat, seawater, pet urine, etc.).
May cause fire, burns, injury, electric shock, etc. Refer to the following for details on water resistance.
→P.12 "Water, Dust, & Shock Resistance"

 **No liquids** Do not allow water or other liquid (beverage, sweat, seawater, pet urine, etc.) to get inside the charger terminal or external connector terminal.
May cause fire, burns, injury, electric shock, etc. Refer to the following for details on water resistance.
→P.12 "Water, Dust, & Shock Resistance"

 **Instruction** Use optional accessories specified by NTT DOCOMO.
Using products other than those specified or of unknown origin of manufacture, sales, or specifications may cause fire, burns, injury, electric shock, etc.

WARNING

 **Don't** Do not subject the equipment to strong force, impact, or vibration by dropping it, stepping on it, or throwing it.
May cause fire, burns, injury, electric shock, etc.

 **Don't** Do not allow conductive materials (such as metal objects and pencil lead) to come into contact with the charger terminal or external connector terminal, or dust to enter them.
May cause fire, burns, injury, electric shock, etc.

 **Don't** Do not cover or wrap the equipment with bedding etc. during use or while charging.
May cause fire, burns, etc.

 **No liquids** When caring for equipment, ensure that no disinfectant or water enters the external connector terminal, earpiece/speaker, or mouthpiece/microphone.
Handset breakage may cause injury, electric shock, etc.

 **Instruction** If charging does not complete after the specified charging time, discontinue charging.
Overcharging may cause fire, burns, injury, etc.

 **Instruction** Always power off handset or stop charging before entering anywhere flammable gas or dust may be generated.
May ignite flammable gases, etc. and cause explosion, fire, etc.

 **Instruction** For use at a gas station or similar location, follow the instructions of the facility.
Do not charge at a gas station or similar location.
If using at a gas station or similar location, be careful not to drop, and in particular, do not use while filling.
May ignite flammable gases, etc. and cause explosion, fire, etc.

 **Instruction** If there is abnormal odor/sound, smoke, overheating, discoloration, distortion, or other abnormalities during use, charging, or storage, do the following while exercising caution.
● Unplug the power plug from the outlet or accessory socket.
● Power off the handset.
● Remove the battery pack from the handset.
Not doing so may cause fire, burns, injury, electric shock, etc.

CAUTION

 **Don't** Do not use damaged equipment.
May cause fire, burns, injury, etc.

 **Don't** Do not leave the equipment on unstable surfaces, such as on a wobbly table or sloped surface. In particular, be careful while handset is set to vibrate.
May fall and cause injury, etc.

 **Don't** Do not store or use the equipment in locations that are subject to humidity, dust, or high temperatures.
May cause fire, burns, electric shock, etc. Refer to the following for details on water/dust resistance.
→P.12 "Water, Dust, & Shock Resistance"

 **Don't** If being used by a child, a guardian should show them the proper way to handle equipment, and not allow improper use.
They may swallow parts, or may cause injury, electric shock, etc.

 **Don't** Do not leave the equipment in the reach of young children or pets.
In particular, be careful where small parts are stored, such as the nano SIM card/microSD card tray.
They may swallow parts, or may cause injury, electric shock, etc.

 **Instruction** Note that equipment may become warm if handset is used for a continued period or while charging. Be careful not to have unintended, continued contact with equipment such as by falling asleep with equipment in pocket, etc.
The handset, battery pack, or adapter may become hot after continued use of apps, data communication, video viewing functions, etc. or while charging. Continued contact with hot parts may cause redness, itchiness, rash, low-temperature burns, etc. depending on the individual.

2. Handling the handset

DANGER

 **Don't** Do not throw the handset into a fire or heat it.
May cause fire, burns, injury, etc.



Don't

Do not apply excessive force to the handset such as by puncturing it (sharp object), hitting it (hard object), or stepping on it. May cause fire, burns, injury, etc.



Instruction

If substance in handset gets in your eyes, mouth, etc., rinse with clean water and consult a doctor immediately. Substances in handset may cause loss of sight or other physical harm.



WARNING



Don't

Do not shine or flash the camera light/light close to other people's eyes. In particular, keep adequate distance from infants. May harm sight. May temporarily blind or startle others, causing injury or other accident.



Don't

Do not shine or flash the camera light/light toward a driver of a car. May hinder driving and cause an accident, etc.



Don't

Do not view a repeatedly flickering screen for a prolonged period. May cause convulsions, loss of consciousness, etc.



Don't

Do not allow water or other liquids (beverage, sweat, seawater, pet urine, etc.), metal (cutter blades, staples, etc.), flammable material, or other foreign objects to enter the slot for the nano SIM card/microSD card tray in the handset. Note the correct locations and orientations for inserting the nano SIM card and microSD card. May cause fire, burns, injury, electric shock, etc.



Don't

Do not expose camera lens to direct sunlight, etc. for a long time. Concentrated light may cause fire, burns, injury, etc.



Instruction

Power off the handset or set it to Airplane mode before going aboard an airplane. Use of handset on board an aircraft is restricted. Follow instructions of the airline. Disable any functions that automatically power on the handset. Radio signals may adversely affect an aircraft's electronic devices. Prohibited use aboard an aircraft may be subject to penalty by law.



Instruction

For use at a hospital, follow the instructions of the institution. Power off the handset in areas where the use of mobile phones is prohibited. Disable any functions that automatically power on the handset. May interfere with the operation of electronic devices and electronic medical devices.



Instruction

When you are on a handsfree call, while ringtone is playing loudly, when in standby, etc., be sure to keep handset at a safe distance from your ears. Adjust to an adequate volume when using earphones with microphone or similar accessory to play games or play back videos/music. When making a handsfree call, handset emits sound loudly. Even in standby, the ringtone or alarm may ring suddenly. Listening to loud sound continuously for a long time may cause hearing impairment or other difficulty. In addition, not being able to hear surroundings may cause an accident.



Instruction

Users with a heart condition should adjust vibration and ringtone volume as needed. Handset suddenly vibrating and ringing for a new call may startle and affect persons with heart conditions.



Instruction

If wearing an electronic medical device or similar apparatus, check with the manufacturer or vendor regarding any effect that radio signals may have on it. Radio signals may adversely affect electronic medical devices, etc.



Instruction

Power off the handset near electronic devices that use precision control or faint signals. Radio signals may cause electronic devices to malfunction or may adversely affect operation. * Take particular care with the following devices: Hearing aids, implanted cardiac pacemakers, implanted cardioverter-defibrillators, other electronic medical devices, and other automatically controlled devices or equipment. If you are using an implanted cardiac pacemaker, implanted cardioverter-defibrillator, or other electronic medical device, check with the manufacturer or vendor regarding any effect that radio signals may have on it.



Instruction

If display or camera lens breaks, be careful with shards of broken glass and exposed handset parts. Touching the broken or exposed parts may cause burns, injury, electric shock, etc.



Instruction

If internal battery leaks or has an unusual smell, immediately cease using handset, and keep it away from fire. Leaking fluid may ignite, causing fire, rupture, etc.



Instruction

Do not allow pets, etc. to bite handset. Internal battery breakage may cause fire, burns, injury, etc.



CAUTION



Don't

Do not swing the handset by its strap, etc. May cause an accident such as injury.

3. Handling the battery pack



- Don't** Do not allow metal objects (necklaces, hairpins, etc.) or conductive materials to come into contact with the connector terminal. Also, do not carry or store the battery pack with such items.
May cause fire, burns, injury, etc.
- Don't** If it is difficult to install the battery pack in the handset, do not try to force it in. Also, if it is difficult to remove the battery pack from the handset, do not remove it forcefully.
May cause fire, burns, injury, etc.
→P.19 "Installing the battery pack"
→P.20 "Removing the battery pack"
- Don't** Do not throw the handset into a fire or heat it.
May cause fire, burns, injury, etc.
- Don't** Do not apply excessive force to the battery pack such as by puncturing it (sharp object), hitting it (hard object), or stepping on it.
May cause fire, burns, injury, etc.

Instruction Check that the battery pack is in the right orientation when installing it in the handset. If installed in the wrong orientation, battery pack breakage may cause fire, burns, injury, etc.
→P.19 "Installing the battery pack"

Instruction If substance in battery pack gets in your eyes, mouth, etc., rinse with clean water and consult a doctor immediately. Substance in battery pack may cause loss of sight or other physical harm.



- Don't** Do not subject the battery pack to strong force, impact, or vibration by dropping it, stepping on it, or throwing it.
May cause fire, burns, injury, electric shock, etc.
- Don't** If there is abnormal odor, overheating, discoloration, distortion, or other abnormalities, do not use.
May cause fire, burns, injury, etc.
- Don't** Cease using the battery pack immediately if it has been subjected to strong impact or it is visibly deformed or broken.
May cause fire, burns, injury, etc.

Instruction If the battery pack leaks or has an unusual smell, immediately cease using it, and keep it away from fire.
Leaking fluid may ignite, causing fire, rupture, etc.

Instruction Do not allow pets, etc. to bite the battery pack.
Battery pack breakage may cause fire, burns, injury, etc.

Don't Before using the motion sensor, ensure safety around you, hold handset firmly, and do not wave more than necessary.
Not doing so may cause injury or other accident.

Don't If display is broken, do not let leaking internal substance get on your skin (face, hands, etc.), clothes, etc.
May harm your eyes, skin, etc.
If substance in handset gets in your eyes, mouth, etc. or on your skin or clothes, immediately rinse with clean water.
If it gets in your eyes, mouth, etc., rinse and immediately consult a doctor.

Don't Do not apply unnecessary force when removing the back cover.
The back cover may break and cause injury, etc.

Don't Be careful not to pinch yourself (finger, etc.) when attaching the back cover.
May cause injury, etc.

Don't Do not use with back cover removed.
May cause burns, injury, electric shock, etc.

Don't Do not dispose of handset together with ordinary trash.
May cause fire, burns, injury, etc. May also adversely affect the environment. Bring old handset where accepted such as a docomo Shop, or follow municipal instructions for recycling.

Don't If substance in internal battery leaks, do not let it get on your skin (face, hands, etc.), clothes, etc.
May harm your eyes, skin, etc.
If substance in handset gets in your eyes, mouth, etc. or on your skin or clothes, immediately rinse with clean water.
If it gets in your eyes, mouth, etc., rinse and immediately consult a doctor.

Instruction Before using the handset in a car, check with the car manufacturer or dealer regarding any effect that radio signals may have on it.
May interfere with the operation of electronic equipment in some vehicle models. In this case, do not use the handset.

Instruction If use of the handset causes any skin abnormalities, immediately stop using the handset and consult a doctor.
Handset use may cause itchiness, skin irritation, rashes, etc. depending on your physical condition.
Refer to the following for details on materials of each part.
→P.9 "Material list"

Instruction Handset earpiece/speaker and camera use magnetic components. Make sure that metal objects (cutter blades, staples, etc.) are not attached to it.
Attached objects may cause injury, etc.

Instruction View the display in a well-lit place at an adequate distance.
Viewing in a dark location or too closely may affect your eyesight.

CAUTION



If substance in the battery pack leaks, do not let it get on your skin (face, hands, etc.), clothes, etc.

Don't

May harm your eyes, skin, etc. If substance in the battery pack gets in your eyes, mouth, etc. or on your skin or clothes, immediately rinse with clean water. If it gets in your eyes, mouth, etc., rinse and immediately consult a doctor.



Do not dispose of battery pack together with ordinary trash.

Don't

May cause fire, burns, injury, etc. May also adversely affect the environment. Bring old battery packs, after insulating the connector terminal with tape, etc., where accepted such as a docomo Shop, or follow municipal instructions for recycling.



Do not use or charge a wet battery pack.

Don't

May cause fire, burns, injury, etc.

4. Handling the adapters

WARNING



Do not use if the cord of the adapter is damaged.

Don't

May cause fire, burns, electric shock, etc.



DC adapters are only for use with minus-earth vehicles. Do not use with plus-earth vehicles.

Don't

May cause fire, burns, electric shock, etc.



Do not touch adapters if you hear thunder.

Don't

May cause electric shock, etc.



Do not short-circuit the charging terminal when connected to an outlet or accessory socket. Do not allow any part of yourself (hands, fingers, etc.) to come in contact with the charging terminal.

Don't

May cause fire, burns, electric shock, etc.



Do not place heavy objects on the cord of the adapter or apply excessive force such as by pulling.

Don't

May cause fire, burns, electric shock, etc.



When plugging/unplugging an AC adapter, keep any metal strap, etc. away.

Don't

May cause fire, burns, electric shock, etc.



Do not use a voltage converter (travel converter for overseas use, etc.) when charging with an AC adapter.

Don't

May ignite, overheat, cause electric shock, etc.



Do not apply excessive force where the adapter is connected to the handset.

Don't

May cause fire, burns, injury, electric shock, etc.



No wet hands

Do not touch AC adapter cord, charging terminal, or power plug with wet hands.

May cause fire, burns, electric shock, etc.



Always use the specified power supply and voltage.

Instruction

Also, use an AC adapter for global use when charging abroad.

Using the incorrect power supply or voltage may cause fire, burns, electric shock, etc. AC adapter: 100 V AC (household AC power outlet only)

AC adapter for global use: 100 V to 240 V AC (household AC power outlet only)

DC adapter: 12 V/24 V DC (only for use with minus-earth vehicle)



Always use a specified fuse when replacing a fuse in a DC adapter.

Instruction

Using unspecified fuses may cause fire, burns, electric shock, etc. See individual instructions regarding specified fuses.



Wipe off any dust on the power plug.

Instruction

Using while dusty may cause fire, burns, electric shock, etc.



Insert the power plug of the adapter in the outlet or accessory socket firmly.

Instruction

Failure to do so may cause fire, burns, electric shock, etc.



When unplugging from an outlet or accessory socket, grasp the adapter body and do not pull the cord or otherwise subject it to excessive force.

Instruction

Pulling the cord of the adapter may damage it and cause fire, burns, electric shock, etc.



Insert or remove the connector of the adapter in/from the handset without bending or applying force such as pulling the cord.

Instruction

Not inserting/removing it correctly may cause fire, burns, injury, or electric shock.



Cease using the adapter immediately if the charging terminal is bent or otherwise deformed. Also, do not repair the charging terminal to use the adapter.

Instruction

Short-circuiting of the charging terminal may cause fire, burns, injury, electric shock, etc.



When not in use, unplug from the outlet or accessory socket.

Unplug

Leaving it plugged in may cause fire, burns, electric shock, etc.



If splashed with water or other liquid (beverage, sweat, seawater, pet urine, etc.), immediately unplug from the outlet or accessory socket.

Unplug

A short-circuit from splashing may cause fire, burns, electric shock, etc.



Always unplug the power plug from the outlet or accessory socket before cleaning the equipment.

Unplug

Cleaning while still plugged in may cause fire, burns, electric shock, etc.

CAUTION



Do not touch an adapter continuously when connected to an outlet or accessory socket. May cause burns, etc.

5. Handling nano SIM cards

CAUTION



Instruction

Be careful not to scratch yourself (finger, etc.) with the edges when handling the nano SIM card. Edges may be sharp and cause injury.

6. Handling near electronic medical devices

WARNING



Instruction

If you have an electronic medical device such as an implanted cardiac pacemaker or an implanted cardioverter-defibrillator, always carry or use your handset at least 15 cm away from your implant. Radio signals may adversely affect operation of electronic medical devices.



Instruction

When using an electric medical device (other than an implanted cardiac pacemaker/defibrillator) outside medical facilities, check with the device manufacturer, etc. regarding any effect that radio signals may have on it. Radio signals may adversely affect operation of electronic medical devices.



Instruction

Disable handset transmissions (e.g. Airplane mode) or power off handset when it is difficult to keep a distance of at least 15 cm away from others such as in a crowd. Someone nearby may be wearing an electronic medical device such as an implanted cardiac pacemaker or an implanted cardioverter-defibrillator. Radio signals may adversely affect operation of electronic medical devices.



Instruction

Observe a medical facility's instructions when using handset. Radio signals may adversely affect operation of electronic medical devices.

7. Material list

■ Handset

Part	Material	Surface treatment
Outer case (display-side, side panel), back cover (around camera)	PC plastic	UV-hardened coating

Part	Material	Surface treatment
Back cover (above camera), back cover, volume up/down button, direct key Left/Right, lock dial	PC plastic	—
Outer case (top/bottom bumpers)	TPU	—
Power button/fingerprint sensor	Epoxy plastic	Thermoset coating
Display, out-camera lens	Chemically strengthened glass	Anti-smudge treatment
Outer panel (camera light/light)	PMMA plastic	—
Case fitting screws	SWCH	Trivalent chromate treatment
nano SIM card/microSD card tray, battery lock	POM plastic	—
Battery pack connection	Copper	Gold plating (on nickel plating)
Nameplate label	PET	—
Rubber gasket	Silicone	—

■ Battery pack KY02

Part	Material	Surface treatment
Exterior	PC plastic	—
Sticker	PET (base)	Matte varnish (surface)
Terminal	Copper	Gold plating (on nickel plating)

Handling precautions

General notes

- Do not allow water or other liquid (beverage, sweat, seawater, pet urine, etc.) or dust or other matter to get inside the handset or to remain on bundled or optional accessories. The battery pack, adapter, and nano SIM card are not waterproof/dustproof. Do not use in humid or steamy areas such as bathrooms and avoid exposing to rain and other forms of moisture. Note that if they are carried on you, perspiration may cause internal components to corrode and result in malfunction.
- Wipe clean with a dry, soft cloth (such as for eye glasses).
 - Wiping forcefully may scratch the display.
 - Allowing moisture or smudges to remain on the display may leave blemishes.
 - Use with terminals and sensors in a soiled condition may prevent normal use.
 - Wiping with thinner, benzene, detergent, etc. may

remove print or fade colors.

- Wiping may be done using a soft cloth dampened with foam hand soap, isopropyl alcohol, ethanol, or sodium hypochlorite (→P.15).

* Immersing the handset or directly spraying isopropyl alcohol, ethanol, or sodium hypochlorite may cause malfunction. Always use a soft, dampened cloth.

- **The handset can be wiped with a disinfectant alcohol sheet or cloth containing a small amount of alcohol (such that the cloth is dampened). The handset has been wipe-tested with the following chemicals used commonly in disinfectant alcohol sheets to test its chemical resistance.**

(1) Isopropyl alcohol, (2) ethanol, (3) sodium hypochlorite

No noticeable discoloration or fading was confirmed in testing assuming wiping with disinfectant alcohol sheets. However, handset resistance is verified under test conditions, and complete non-occurrence of discoloration or fading is not guaranteed.

- **Do not place the equipment near an air conditioning vent.**

Condensation from rapid changes in temperature may cause internal corrosion and lead to a malfunction.

- **Do not subject the handset, battery pack, etc. to excessive force.**

Placing in a bag or other storage where many other things are stuffed, or carrying in a pocket and sitting down can cause display, internal circuitry, internal battery or battery pack, etc. to malfunction or break. May also cause malfunction or damage while an external device is connected to the external connector terminal.

- **Use optional accessories specified by NTT DOCOMO.**

Using unspecified accessories may cause malfunction or damage.

- **Avoid using the handset in extremely high or low temperatures.**

Use the handset within a temperature range of between 5° C and 35° C and a humidity between 35% and 85%.

- AC adapter

- **Avoid using the handset in extremely high or low temperatures.**

Use the handset within a temperature range of between 5° C and 35° C (temporary use between 36° C and 40° C allowable) and a humidity range of between 35% and 90%.

- KY-51D

- Battery pack

- **Back up personal files saved on the handset to microSD card, computer, the cloud, etc. or make a separate note.**

DOCOMO is not responsible for any saved data that is lost.

Notes about the handset

- **Do not press the display forcefully, and do not operate with anything pointed.**

May scratch the handset and cause malfunction or damage.

- **Use near an electronic appliance (TV, radio, etc.) may cause interference. Distance the handset as much as possible.**

- **Do not leave where camera lens is exposed to direct sunlight.**

Concentrated sunlight through lens may discolor or burn the imaging element.

- **Always use with the back cover, etc. closed.**

Water or other liquids (beverage, sweat, seawater, pet urine, etc.) or dust intrusion may cause malfunction.

- **Do not use with back cover removed.**

May allow the battery pack to come loose, causing malfunction or damage.

- **Do not subject fingerprint sensor to strong impact or scratch it.**

May cause fingerprint sensor to malfunction, and may prevent authentication.

- **While the handset is accessing the microSD card, do not remove the card or power off the handset.**

May cause data to be erased or may cause malfunction.

- **Do not place magnetic stripe cards or magnetic objects near the handset.**

Information saved on cash cards, credit cards, commuter IC cards, etc. may be erased.

- **A strong magnetic field may also cause the handset to malfunction.**

- **Do not decorate the handset with films or stickers.**

Functions that require the proximity sensor may not operate correctly.

For location of the proximity sensor, see below.

→P.18 "Part names and functions"

- **Internal battery usable time depends on environment of usage and internal battery deterioration.**

- **To help maintain performance and life of the internal battery, store the handset in the following conditions.**

- Before storing for a long time, power off the handset and store at normal temperature.
- If the handset is going to be left unused for more than 2 years, power it on and leave it for at least 3 hours on a regular basis.

- **Handset internal battery is the following type.**

Display	Battery type
Li-ion 00	Lithium-ion battery

Notes about the battery pack

- **Battery pack usable time depends on environment of usage and battery pack deterioration.**

- **To help maintain performance and life of the battery pack, do not store the battery pack in the following conditions.**

- Full (immediately after charging is complete)
 - Exhausted (too low to power on the handset)
- Optimal battery level for storage is 40 percent.

- **When swapping the battery pack, work in surroundings where dirt, dust, water, etc. cannot enter the handset. Avoid swapping the battery pack while outdoors, etc.**

- **While carrying the battery pack, do not allow the battery or terminals to become scratched.**

- Battery pack is the following type.

Display	Battery type
Li-ion 00	Lithium-ion battery

Notes about adapters

- Do not charge in these locations.
 - Where there is much humidity, dust, or vibration
 - Near an electronic device (TV, radio, etc.)
- If charging using a DC adapter, do not use with the vehicle's engine turned off.

May drain the vehicle's battery.
- If using an outlet with a protector to prevent unplugging, follow the instructions for the outlet.

Notes about the nano SIM card

- Do not apply unnecessary force when inserting/removing the nano SIM card.
- Customer is responsible for malfunction caused by use after having inserted the nano SIM card in an other-brand IC card reader/writer, etc.
- Clean the IC area from time to time to maintain it in clean condition.

Use in a soiled condition may prevent normal use.
- To protect the environment, take old nano SIM cards to where they are collected such as a docomo Shop.
- Do not scratch, carelessly touch, or short-circuit the IC.

May cause data to be erased or may cause malfunction.
- Do not subject the nano SIM card to the following.
 - Bending or placing heavy objects on it
 - Installing in the handset with a label or sticker on it

Notes on using the Bluetooth function

- The handset is equipped with Bluetooth-compliant security features for communication via Bluetooth. However, these may be inadequate depending on settings. Be aware when using Bluetooth.
- DOCOMO is not responsible for any information which may be leaked during communication via Bluetooth.
- Frequency bands

To check frequency bands the handset Bluetooth function uses: in the home screen, [Ⓜ] ▶ [Settings] ▶ [About phone] ▶ [Compliance information]. Label markings are as follows.

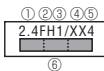

- ① 2.4: Wireless facility using 2400 MHz band.
- ② FH: FH-SS modulation.
- ③ 1: Expected maximum interference range of about 10 m.
- ④ XX: Other-method modulation.
- ⑤ 4: Expected maximum interference range of about 40 m.

- ⑥ Utilizes 2,400 MHz to 2,483.5 MHz band without mobile device bandwidth differentiation.

Use of handset Bluetooth function is restricted in some countries/regions. Be sure to check laws and other conditions of the country/region. Before using aboard an aircraft, check with the airline beforehand.

- Cautions on using Bluetooth devices

The handset uses the same frequency band as used by household appliances such as microwave ovens and industrial, scientific, and medical equipment, (licensed) premises radio stations used to identify mobile units used in manufacturing lines, (unlicensed) specified low-power radio stations, and amateur radio stations (below, "other radio stations").

 1. Before using handset, check that other radio stations are not in use nearby.
 2. If interference should occur with other radio stations, immediately change handset location or power off the handset to avoid interference.
 3. Contact the number listed on the last page.

Notes about wireless LAN (WLAN)

- A wireless LAN (WLAN) exchanges information using radio signals, and allows you to freely establish a LAN connection if you are within an area where radio signals reach. However, communication without appropriate security settings may allow communication to be intercepted by malicious parties. It is recommended to make security settings, and is at your discretion.
- DOCOMO is not responsible for any information which may be leaked during communication via wireless LAN.
- Wireless LAN

Do not use where there are devices with magnetic fields (electrical products, AV/OA equipment, etc.) or where there is an electromagnetic field.

 - Magnetic fields may increase electrical noise or may affect communication (especially when using a microwave oven).
 - It may interfere with reception if near a TV, radio, etc., or the TV screen may become unviewable.
 - If multiple wireless LAN access points using the same channel are in proximity, handset may not detect access points correctly.
- Frequency bands

To check frequency bands the handset wireless LAN function uses: in the home screen, [Ⓜ] ▶ [Settings] ▶ [About phone] ▶ [Compliance information]. Label markings are as follows.

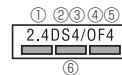

- ① 2.4: Wireless facility using 2400 MHz band.
- ② DS: DS-SS modulation.
- ③ 4: Expected maximum interference range of about 40 m.
- ④ OF: OFDM modulation.

⑤ 4: Expected maximum interference range of about 40 m.

⑥ : Utilizes 2,400 MHz to 2,483.5 MHz band with mobile device bandwidth differentiation. Usable channels depend on the country. Before using aboard an aircraft, check with the airline beforehand.

● Cautions on using 2.4 GHz devices

WLAN devices use the same frequency band used by household appliances (microwave ovens) and industrial, scientific, and medical equipment as well as by premises radio stations (requiring a license) and specific low-power radio stations (not requiring a license) for mobile identification as used in production lines, and by amateur radio stations (requiring a license).

1. Before using the handset, check that no premises radio stations for mobile identification, specific low-power radio stations, or amateur radio stations are in operation nearby.
2. If use of the handset causes interference with regard to an in-place radio stations for mobile identification, immediately change the usage frequency, or discontinue use, then contact the number on the last page and ask about ways to avoid interference (putting a partition in place, etc.).
3. If the handset is otherwise a cause of interference with regard to specific low-power radio stations for mobile identification or amateur radio stations and assistance is required, contact the number on the last page.

● Cautions on using 5 GHz devices

Using a 5.2/5.3-GHz-band wireless LAN outdoors is prohibited by law (this does not apply to communication with access points/relay stations of high-output data communications systems operating in the 5.2 GHz band).

Handset uses the following channels.

- W52 (5.2 GHz band / 36, 40, 44, 48 ch)
- W53 (5.3 GHz band / 52, 56, 60, 64 ch)
- W56 (5.6 GHz band / 100, 104, 108, 112, 116, 120, 124, 128, 132, 136, 140, 144 ch)

Notes about FeliCa® and NFC reader/writer

- The handset FeliCa and NFC reader/writer functions use faint radio signals that do not require a radio station license.
- The frequency used is the 13.56 MHz band. If other FeliCa and NFC reader/writers are used nearby, keep an adequate distance from them. Also make sure that other radio stations using the same frequency band are not nearby.
- Before using aboard an aircraft, check with the airline beforehand. Use may be restricted depending on the country. Be sure to check laws and other conditions of the country/region.

CAUTION

- **Never use the handset if modified. Using the handset if modified is a violation of the Radio Law and the Telecommunications Business Law.**
The handset has received certification of compliance with technical standards as a specific wireless device based on the Radio Law as well as compliance with technical standards as a device based on the Telecommunications Business Law, indicated by the "technical conformity mark" on its electronic nameplate. To check the electronic nameplate:
In the home screen, [] ▶ [Settings] ▶ [About phone] ▶ [Compliance information]
Removing handset screws and modifying the handset voids technical conformity certification. Using handset with its certification voided is a violation of the Radio Law and the Telecommunications Business Law. Never use with certification voided.
- **Be careful of using the handset while driving a vehicle or riding a motorcycle/moped or bicycle.**
Other than where excepted by law, looking at handset screen or taking the handset in your hand to talk while driving are subject to prosecution.
- **The handset FeliCa and NFC reader/writer functions are compliant with Japanese domestic wireless standards.**
Before using them abroad, check conditions such as regulations of the country/region to use the function.
- **Do not change the base software without authorization.**
This is regarded as software modification, and the handset may be refused for malfunction repair.

Water, Dust, & Shock Resistance

KY-51D has IPX5*1 and IPX8*2 water resistance, as well as IP6X*3 dust resistance on the condition that the back cover is securely attached. The handset also has shock resistance compliant with MIL standards*4 (Kyocera testing methods).

- *1 IPX5: handset retains phone functioning after being subjected to a jet flow (12.5 L/min) discharged from a nozzle (inner diameter: 6.3 mm), from all directions (approximately 3 m from the handset) for 3 minutes or more.
- *2 IPX8: phone unit experiences no seepage and retains phone functioning after it is slowly submerged to depth of 1.5 m in standing tap water at room temperature, left there for approximately 30 minutes and then taken out.
- *3 IP6X: indicates that handset is able to prevent intrusion of dust after being placed in a test device with 75 μm or smaller particles for 8 hours.
- *4 MIL standards
Compliance with original durability test items in addition to 21 durability test items of MIL-STD-810H as defined by the U.S. Department of Defense.

* Shock resistance assumes usual everyday use. The handset may break if subjected to excessive shock such as being thrown or dropped forcibly. Even if handset continues to function normally, dropping it may cause scratches, etc.

■ MIL-STD-810H items

Blowing rain	Tested with rainfall of 1.7 mm/min. for 30 minutes at a time from 6 directions, and tested with rainfall for 30 minutes in windspeed conditions of 18 m/s
Immersion	Tested by immersing in water to a depth of about 1.5 m for 30 minutes
Steady state rain	Water resistance tested with rainfall from a height of 1 m (15 minutes)
Sand and dust	Sand and dust test done continuously for 6 hours (windspeed 8.9 m/s, concentration 10.6 g/m ³)
Drop	Tested by dropping onto a steel plate in 26 directions from a height of about 1.22 m
Shock	Tested by attaching the device to a shock test device, and subjecting it to shock of 40 G from 6 directions 3 times
Vibration	Vibration-tested for 3 hours (3 directions, 1 hour each / 20 to 2,000 Hz)
Solar radiation	Tested by continuous exposure for 20 hours to 1,120 W/m ² of sunlight, then no exposure for 4 hours, repeated over 10 days
Humidity	Tested in continuous high humidity (95% RH) over 10 days
High temperature storage	Endurance-tested in high temperature of 60° C continuously for 4 hours Tested for high-temperature storage by changing temperature from 30° C to 60° C
High temperature operation	Operation-tested for 3 hours fixed at 50° C Operation-tested through 3 cycles of temperature change from 32° C to 49° C
Low temperature operation	Operation-tested at low temperature for 3 hours fixed at -21° C Tested for storage in low temperature of -30° C continuously for 4 hours
Temperature endurance/temperature shock	Endurance-tested for temperature continuously for 3 hours by suddenly changing the temperature from -21° C to 50° C
Low pressure storage	Tested for storage at low pressure continuously for 2 hours (57.2 kPa/ equivalent to an altitude of about 4,572 m)
Low pressure operation	Tested for operation at low pressure continuously for 2 hours (57.2 kPa/ equivalent to an altitude of about 4,572 m)

Icing/condensation	Tested in condensation and fog at -10° C generated and maintained for 1 hour, then operation checked at 25° C, 95% RH
Icing/freezing rain	Tested by freezing under conditions of -10° C until thickness of ice on test item is 6 mm
Salt fog	Endurance-tested for salt water by misting 5% salt water continuously for 24 hours, then drying for 24 hours

■ Kyocera original test items

Drop	Tested by dropping onto concrete in 26 directions from a height of about 1.8 m
Tumble	Tested by dropping 500 times continuously from a height of about 1.0 m
Steel ball drop	Tested by dropping a steel ball of about 100 g from a height of 1 m onto the display surface
L-angle drop	Tested by dropping onto an iron L-angle from a height of about 1.5 m
Weight endurance	Tested by applying about 100 kgf evenly on the surface
High temperature storage	Endurance-tested in high temperature of 70° C continuously for 4 hours Tested for high-temperature endurance by changing temperature from 30° C to 70° C
High temperature operation	Operation-tested at 60° C continuously for 3 hours
Foam hand soap wash	Tested in a wash cycle by hand-washing and rinsing using foam hand soap/foam body soap
Chemical endurance	Tested by wiping with a soft cloth dampened with a small amount of isopropyl alcohol, ethanol, and sodium hypochlorite

- Operation is not guaranteed for all conditions. Warranty does not cover malfunctions resulting from misuse.

Precautions before use

- Close the back cover securely. The handset is water and dust resistant when the tray is secured completely.
- Never open or close the back cover while hands or the handset is wet.
- Do not immerse or expose the handset to liquids other than water (alcohol, seawater, pool water, hot spring water, soap, detergent, water with bath salts, drink, alcohol beverage, food seasoning, etc.). Also do not use where exposed to pet urine. If exposed, immediately rinse with tap water.
- Do not place directly on a sandy beach, etc. Sand, etc. in mouthpiece/microphone, earpiece/speaker, or other part may affect sound, and sand entering the handset may cause overheating or malfunction.
- Do not use under water.
- Do not use or store for a prolonged period in a

bathroom, kitchen, or other humid place.

- Moisture may remain after draining. This does not affect the handset, however, do not place the handset near items you do not want to become wet. Use care, as it can cause wetting inside clothing or a bag.
- If water is remaining in the USB Type-C connector terminal, do not use it.
- Drain any moisture that has collected in the mouthpiece/microphone, earpiece/speaker, or other part and is causing sound to be inaudible.
- The handset is not designed to be water resistant. Do not subject to direct, high water pressure or submerge under water for a long period.
- Do not wash in a washing machine, sonic washer, etc.
- Do not immerse in a bathtub. The handset is not designed to be heat resistant.
- Condensation from rapid changes in temperature may cause malfunction. Before bringing the handset into a bath room or other warm place from a cold place, let it adjust to room temperature.
- The handset does not float on water.

Back cover

- Completely close the back cover. Anything tiny (a single hair, etc.) caught in the sealing surfaces may allow ingress of water.
- Do not wear gloves when removing or attaching the back cover. Anything tiny (a single hair, etc.) caught in the sealing surfaces may allow ingress of water. When closing the cover, wipe away any moisture or dirt with a dry, clean cloth, even if it only appears very small.
- A deteriorating or damaged back cover will not allow the handset to be water resistant.

Attaching the back cover

For attaching the back cover, see "Installing the battery pack" (→P.19).

If liquid other than water is on handset

- Wiping may be done using a soft cloth dampened with foam hand soap, isopropyl alcohol, ethanol, or sodium hypochlorite (→P.15).
- The handset can be washed with low-pressure water flow (6 L/min or less tap water at room temperature (between 5° C and 35° C)), holding it approximately 10 cm below the faucet or shower head.
- If soiled, hold the handset making sure the back cover cannot open, and hand-wash without using a brush.

After becoming wet with water

- After the handset has become wet with water, drain water and wipe away moisture with a dry, clean cloth.
- In cold regions, any moisture on the handset may freeze. Using the handset with frozen moisture may cause malfunction. Do not leave wet.

Rubber gasket

- Be careful not to pinch the rubber gasket when attaching the back cover. Forcing the back cover on with the rubber gasket pinched will scratch the

gasket and may affect water resistance. Anything tiny (a single hair, etc.) caught in the sealing surfaces may allow ingress of water.

- Any liquid other than water on the gasket may affect gasket durability.
- Do not insert anything pointed in the back cover gaps. May damage or deform the handset, and may scratch the gasket and allow ingress of water.
- The rubber gasket at the back cover and handset sealing surfaces is important to handset water and dust resistance. Do not remove or scratch it. Do not allow dirt to get on the gasket. If the rubber gasket is scratched or deformed, have it replaced at a docomo-designated repair counter. Note that repairs may be for a fee depending on the condition of handset.

Heat resistance

- Do not immerse or splash with hot water. To not expose to hot air as in a sauna or from a dryer. The handset is not designed to be heat resistant.

Dust resistance

- If any dust is on the handset, immediately rinse or otherwise remove completely before using the handset.

Impact

- While the handset is shock resistant, shock resistance assumes usual everyday use. The handset may break if subjected to excessive shock such as being thrown or dropped forcibly.

NOTE

- To maintain water and dust resistance, it is recommended to replace parts every 2 years regardless of their condition. The handset can be brought to a docomo-designated repair location for parts replacement at a fee.

Caring for the handset

Soiling on the handset can be cleaned with foam hand soap, alcohol, etc.

- Before caring for the handset, power off the handset and remove all wire connections.

If using foam hand soap/foam body soap

- 1 Power off the handset
- 2 Wash hands and wipe away any moisture. Dispense hand soap/body soap onto hand, work it into a lather, then take the handset and wash both the front and back with a rubbing motion

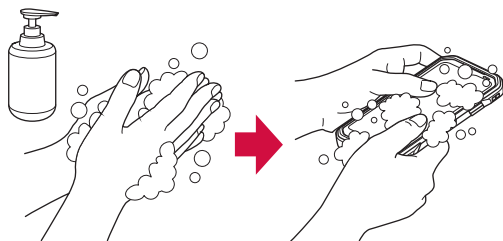

3 Rinse until all hand soap/body soap on the front, back, each key, etc. is completely removed

- With the back cover still attached, rinse the following locations with low-pressure water (6 L/min or less) (→). Any hand soap/body soap remaining may cause malfunction. If any soap suds are remaining, rinse well until all suds are removed.

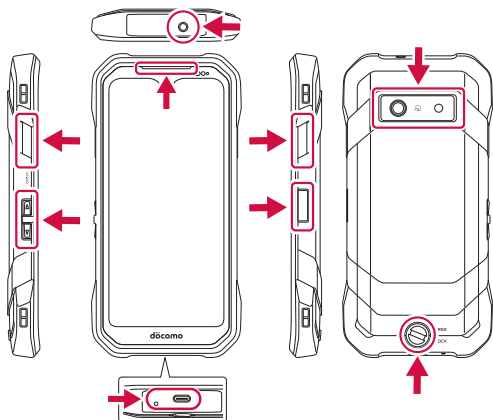
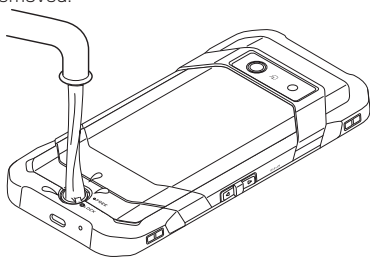

4 Drain water referring to "Draining water when the handset gets wet" (→P.16)

5 Dry adequately, and check that no moisture is remaining

NOTE

- Be sure to remove any store-bought accessories (handset covers, cases, etc.). Check precautions given for store-bought accessories.

- Do not use: alkaline hand soap/body soap or business hand soap/body soap, soap, detergent, bath salts, shampoo, rinse, facial cleanser, makeup remover, toothpaste, etc. If on the handset, immediately rinse with water.
- Do not mix different types of hand soap/body soap.
- Handset resistance is verified under test conditions, and non-occurrence of malfunction is not guaranteed.
- Do not apply hand soap/body soap liquid directly. If liquid is on the handset, immediately rinse with water.
- The handset is not designed to be water resistant. Do not subject to direct, high water pressure or submerge under water for a long period.
- Wash by using only your hands, not a brush or sponge, after ensuring the back cover is closed securely (→P.19).
- Do not wash in a washing machine, sonic washer, dishwasher, etc.
- To prevent scratching the handset when washing it, remove any hand jewelry (wrist watches, rings, applique nails, etc.).
- Since sudden changes in temperature can allow ingress of water into the handset, do not wash the handset in chilly or excessively warm conditions. Wash the handset in room temperature (about 25° C) conditions.

If using alcohol

1 Dab a lint-free, soft cloth with a small amount of isopropyl alcohol (99.7% or less), ethanol (99.5% or less), or sodium hypochlorite (1.0% or less) (such that the cloth is dampened), and wipe the handset.

- * No noticeable discoloration or fading was confirmed in testing assuming wiping with disinfectant alcohol sheets. However, handset resistance is verified under test conditions, and complete non-occurrence of discoloration or fading is not guaranteed.
- * Always carefully read instructions for using any of isopropyl alcohol, ethanol, or sodium hypochlorite sold as a disinfectant. Improper use can pose risks to health and as a flammable substance.
- * Immersing the handset or directly spraying isopropyl alcohol, ethanol, or sodium hypochlorite may cause malfunction. Always use a soft, cloth with a small amount of the cleaner (enough to dampen the cloth).

NOTE

- Be sure to remove any store-bought accessories (straps, etc.) Check precautions given for store-bought accessories.

When charging

Accessories and optional parts are not waterproof/dustproof. Check the following when and after charging.

- Never charge the handset while it is wet. May cause fire, burns, injury, electric shock, etc.
- Check that the handset is not wet. Before charging wet handset, first drain well, then wipe away moisture with a dry, clean cloth, and let dry at room temperature for at least an hour before charging.
- Do not touch a specified AC adapter (sold separately) with wet hands. May cause electric shock.
- Use a specified AC adapter (sold separately) where not exposed to water, and do not use them near water sources (bath room, shower, sink, basin, etc.). May cause fire, burns, electric shock, malfunction, etc. Even when not charging, do not bring in a bath room, etc. May cause fire, burns, electric shock, malfunction, etc.
- Check that no moisture or dirt remains in the USB Type-C connector terminal before use.

Draining water when the handset gets wet

If the handset is wet with water, always drain the mouthpiece/microphone, earpiece/speaker, etc. Continuing to use the handset wet may cause wetting inside clothing or a bag or cause sound to be inaudible.

- ① Wipe off water on the handset with a lint-free, dry, clean cloth



- ② Shake the handset

- ① Hold the handset firmly and shake as shown until no more water drains out
 - Check first that it is safe around you to shake handset.
 - Hold the handset firmly so it does not fly out of your hand when draining water.

Earpiece/speaker side:
at least 20 times each

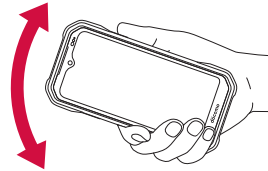

Mouthpiece/microphone:
at least 20 times each

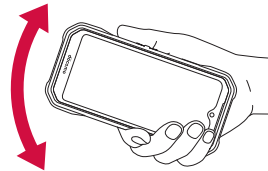

- ② Wipe off any water draining from the handset
 - Water is particularly difficult to drain from the mouthpiece/microphone, earpiece/speaker, earphone mic terminal, USB Type-C connector terminal, and keys. Hold each downward and pat on cloth to wipe.

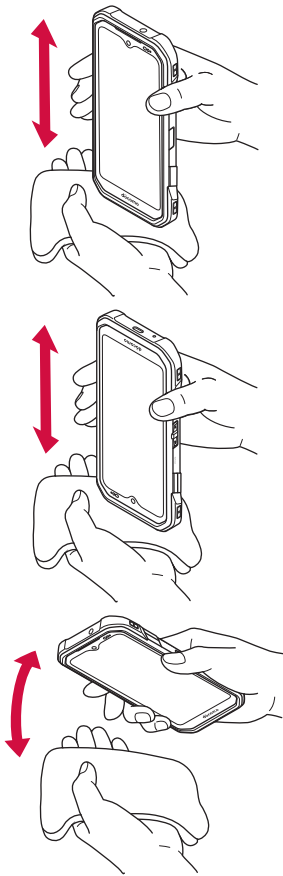

③ Place on a dry towel or cloth, and leave for a while to dry at room temperature

3 After adequately removing moisture from the handset, leave it to dry for at least an hour at normal temperature

- Moisture may be remaining in the handset. Do not place the handset near items you do not want to become wet. Use care, as it can cause wetting inside clothing or a bag.
- Check that no moisture or dirt remains in the USB Type-C connector terminal before use.

Preparing to Use the Handset

Part names and functions

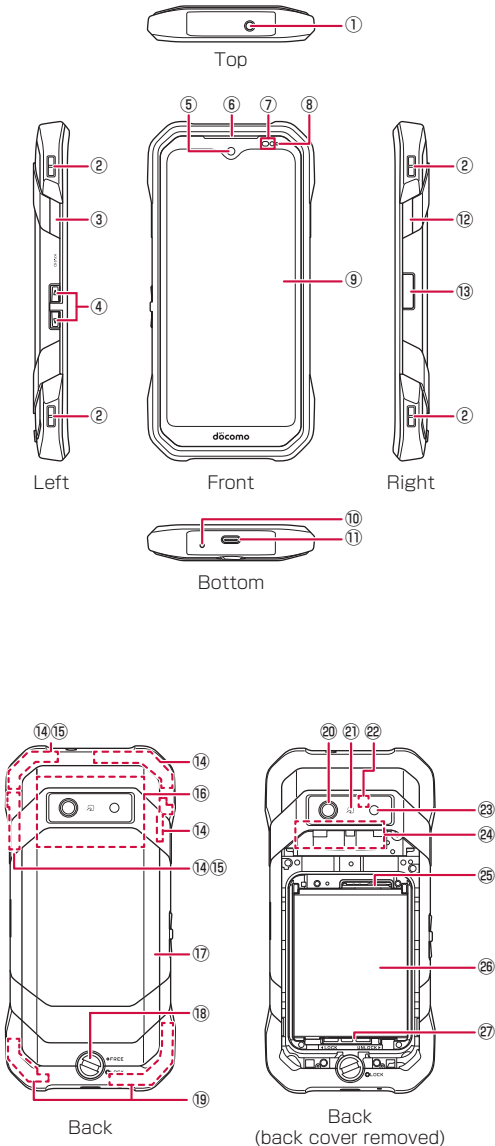

- ① earphone mic terminal
- ② Straphole
- ③ : Direct key Left
 - Single-press, Double-press, or press and hold to activate each set function (→P.30).
- ④ : Volume up/down button
 - Adjust call volume, etc.
- ⑤ In-camera
- ⑥ Earpiece/speaker
 - Hear the other party's voice during a call, ringtone, music, alarm, etc.
- ⑦ Proximity/light sensor*1
 - Proximity sensor detects your face close to handset and prevents touchscreen misoperation during calls.
 - Light sensor adjusts display brightness according to the ambient light.
- ⑧ Charging lamp
 - Lights red while charging.
- ⑨ Display (touchscreen)
- ⑩ Mouthpiece/microphone
 - Talk to the other party during a call, or use when recording a call.
- ⑪ USB Type-C connector terminal
 - Use to charge, etc. Compatible with USB Power Delivery.
- ⑫ : Direct key Right
 - Single-press, Double-press, or press and hold to activate each set function (→P.30).
- ⑬ : Power button/fingerprint sensor*1
 - Enter/exit sleep mode (→P.26).
 - Press and hold until the screen turns on to power on the handset (→P.25).
 - Press for at least 1 second with handset powered for menu. Tap [Emergency], [Power off], [Restart], [Screenshot], or [Battery swap] (→P.25).
 - If a fingerprint is registered, you can use Fingerprint Unlock to unlock the screen (→P.70).
- ⑭ Internal antenna areas*2
- ⑮ Internal Bluetooth/Wi-Fi antenna areas*2
- ⑯ NFC (FeliCa) antenna area*2
- ⑰ Back cover
- ⑱ Lock dial
- ⑲ Main antenna areas*2
- ⑳ Out-camera
- ㉑ mark →P.55
 - Hold the mark up to a scanning device and use handset as an Osaifu-Keitai.
- ㉒ Sub-mic
- ㉓ Camera light/light
- ㉔ Internal battery
- ㉕ nano SIM card/microSD card tray
- ㉖ Battery pack
- ㉗ Battery lock

*1 Do not apply stickers or other coverings over the sensors.

*2 Built into the main body. Covering with hand may affect transmission quality.

Battery pack

Always use Battery Pack KY02 designed for this handset.

- The battery pack is not waterproof.

Installing/removing the battery pack

Installing the battery pack

- Place the handset with its back up.

- 1 Turn the lock dial counter-clockwise
 - Turn until the dial is at "FREE".

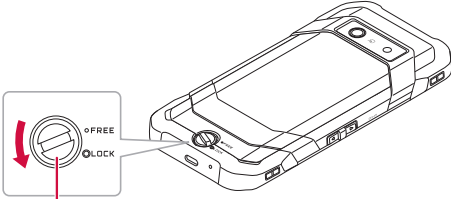

Lock dial

- 2 Remove the back cover

- Hook your fingertips (nails) in the gaps in the back cover, and pull up as shown to remove.

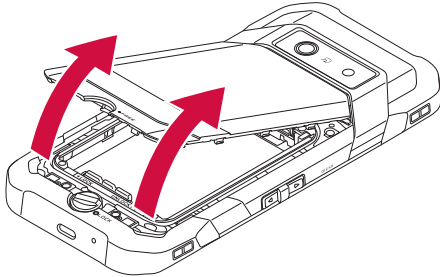

- 3 Slide the battery lock toward "UNLOCK" (to the right)

- The battery lock unlocks. The battery lock must be unlocked before the battery pack can be attached.

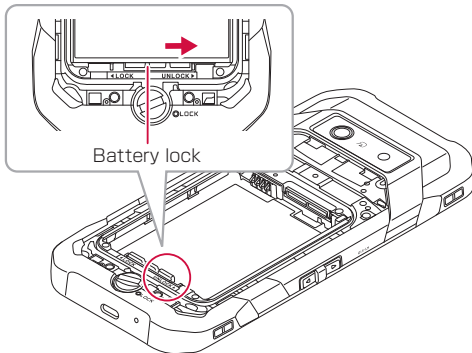

Battery lock

- 4 Install the battery pack

- Check that the nano SIM card/microSD card tray is attached securely before attaching the battery pack.
- Check where the battery pack attaches, and slide the battery pack in and press it in securely.

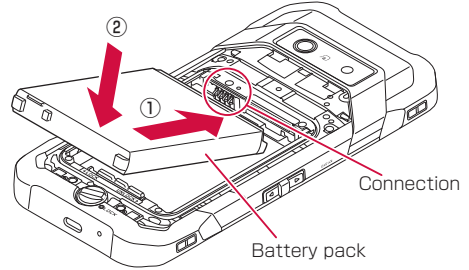

Connection

Battery pack

- 5 Slide the battery lock toward "LOCK" (to the left)

- The battery lock locks, and the battery pack is secured in place.

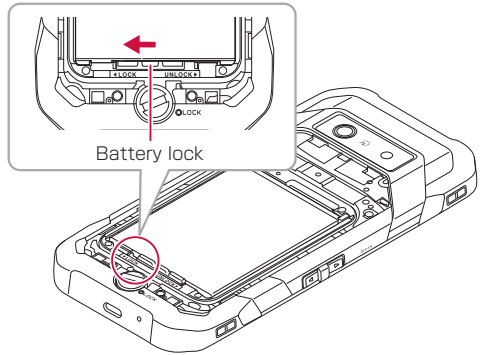

Battery lock

- 6 Attach the back cover

- Check that the lock dial is at "FREE".
- Insert the two tabs on the back cover in the slots at the top of the handset (①), then press down the back cover (②).

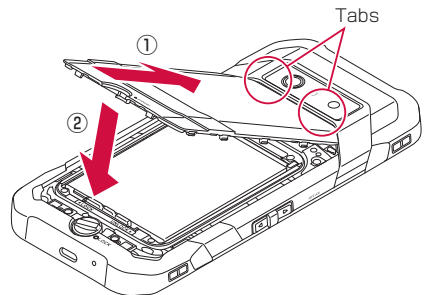

Tabs

- 7** Press the back cover down where shown, then in order from the top of the handset (camera end), make sure there are no gaps all around the back cover to close it securely

- Check that the lock dial is at "FREE" and the battery lock is at "LOCK". Trying to forcefully install the back cover may damage it.
- The battery lock must be unlocked before the back cover can be closed.
- The handset is not water and dust resistant if the back cover has gaps. Also be sure to check visually that the back cover is closed securely after installing it.

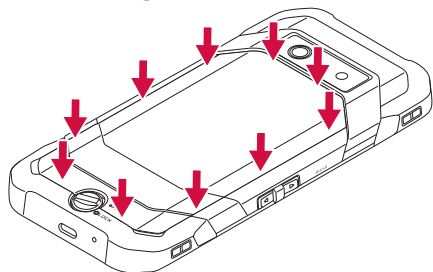

- 8** Turn the lock dial clockwise

- Turn until the dial is at "LOCK". When locked, ○ on the left of "LOCK" is red.

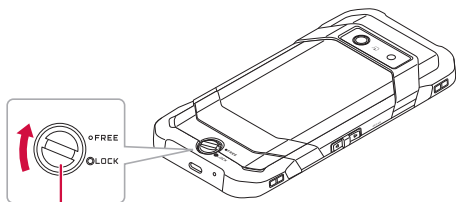

Lock dial

Removing the battery pack

- When removing the battery pack, power off the handset.
- You can swap the battery pack while the handset is powered on (→P.20).

- 1** Remove the back cover (→P.19)
- 2** Slide the battery lock toward "UNLOCK" (to the right)
 - The battery lock unlocks, and the battery pack is desecured.

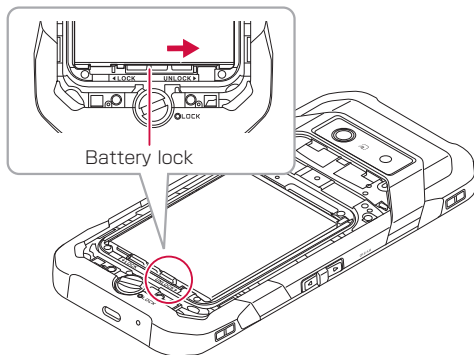

- 3** Remove the battery pack

- Hook your finger nail on the tab on the battery pack, and lift to remove.

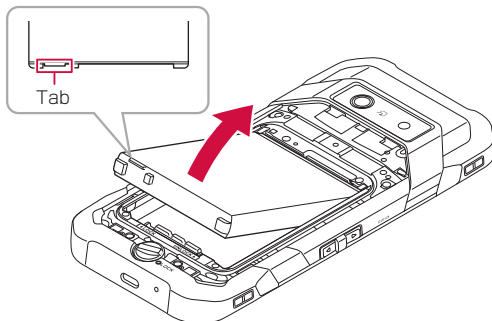



- 4** Slide the battery lock toward "LOCK" (to the left), then attach the back cover (→P.19)

NOTE

- Do not use a screwdriver or other tool to remove the battery pack. Doing so may damage the battery pack.

Swapping the battery pack while the handset is powered on

- 1** Long-press  (power button) (at least 1 second)
- 2** [Battery swap]
 - The first time you swap the battery, a description of the steps for swapping is displayed. Flick the screen to the left, or tap "NEXT" and confirm the content.
- 3** [Start]
 - To view the description of the steps for swapping the battery at any time, tap "Check the details and start".
 - The battery can be swapped when the charging lamp changes from blinking red to remaining lit green.

- While an app or the system is processing, battery swapping is canceled without the charging lamp turning to remaining lit green. Try again after exiting the running app.
- To cancel battery swapping, press  (power button) while the charging lamp is blinking red.
 - * A battery swap cannot be canceled after the charging lamp remains lit green. Follow the steps to swap the battery.

4 Swap with the new battery pack referring to "Removing the battery pack" (→P.20) / "Installing the battery pack" (→P.19)

- After removing the battery pack, swap it with the new battery pack within 2 minutes. The handset will power off if the battery swap is not completed within 2 minutes. Use caution, as unsaved data may be lost.

5 Press and hold  (power button) until the screen turns on

NOTE

- To prevent loss of data or system errors while swapping the battery, remove any cable or devices from the USB Type-C connector terminal, and avoid removing or installing the nano SIM card/microSD card tray.
- If a microSD card is set as storage, storage location or other settings may be changed while the battery is being swapped. Make storage settings per individual app again after swapping batteries.
- Data communication stops during battery swapping. Calls and emergency alerts are not received.
- A message is displayed when the internal battery starts deteriorating. Tap "CONTINUE" to continue the battery swap. However, it is then recommended to replace the internal battery. The handset can be submitted for internal battery replacement at a fee. To apply for repairs, see "Warranty and after-sales service" (→P.88).
- A message is displayed if the internal battery has an abnormality, and the battery swap is canceled. Tap "OK", and have the internal battery replaced.
- A battery swap cannot be done at an extremely warm or cold temperature. Use the handset in a temperature range of 5° C to 35° C.
- If the terminals on the battery pack being swapped are soiled or dusty, wipe the terminals gently with a dry, soft cloth.
- If a SIM PIN is set for the nano SIM card/eSIM (→P. 27), a screen is displayed for entering the SIM PIN after swapping batteries. Enter SIM PIN.

SIM

The handset supports nano SIM cards and eSIMs. If using a nano SIM card and an eSIM at the same time, you can select which SIM to use when using calling, packet communication, etc. However, note that simultaneous use of the nano SIM card and an eSIM may cause services or functions that you use to be restricted.

- You cannot use functions such as the phone or packet communication without inserting a nano SIM card or installing an eSIM.
- Within Japan, a nano SIM card or eSIM must be installed to make emergency calls (110, 119, 118).

Security code for nano SIM card/eSIM

A nano SIM card/eSIM has a security code called the SIM PIN (→P.27).

nano SIM card

The nano SIM card is an IC card that contains personal information, such as your phone number.

- The handset accepts only a nano SIM card. If you have a docomo mini UIM card, docomo UIM card, or FOMA card, bring it to a docomo Shop for replacement.
- Make sure not to touch or scratch the IC (metal) side on the nano SIM card when handling it. Also, note that inserting or removing the nano SIM card forcibly may damage it or deform the nano SIM card/microSD card tray.
- Refer to the NTT DOCOMO website for more information on nano SIM cards.

Installing/removing a nano SIM card

- When installing/removing a nano SIM card, power off the handset and place it with its back up, and remove the back cover and battery pack (→P.20). After installation/removal, replace the back cover and battery pack (→P.19).

Installing a nano SIM card

- 1 Pull the nano SIM card/microSD card tray out straight**

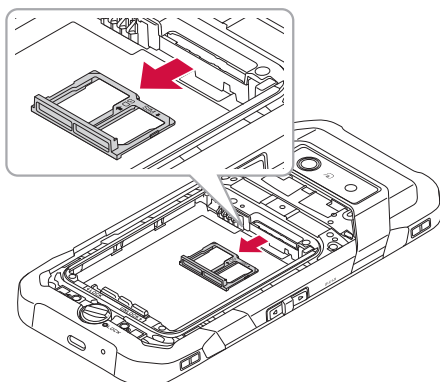

- 2 Set the nano SIM card into the nano SIM card/microSD card tray with the IC chip (metal) side facing down

- Note the location of the notch.
- Make sure the nano SIM card is in the nano SIM card/microSD card tray securely.

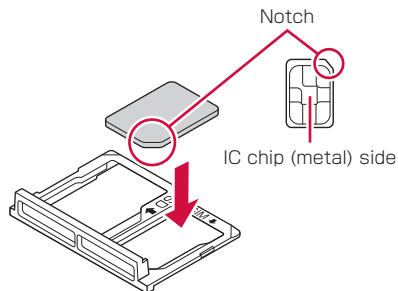

- 3 Insert the nano SIM card/microSD card tray in the handset, and press it in straight all the way

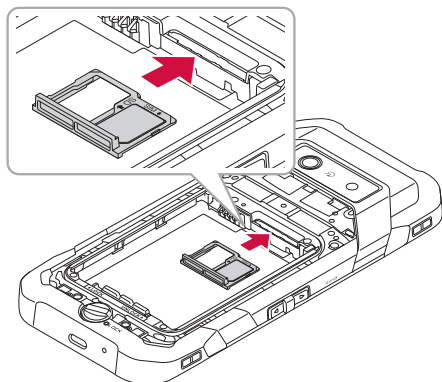

Removing a nano SIM card

- 1 Pull the nano SIM card/microSD card tray out straight

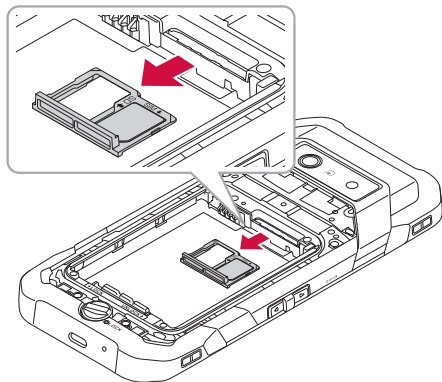

- 2 Remove the nano SIM card from the nano SIM card/microSD card tray

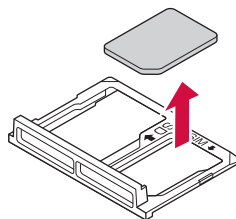

- 3 Insert the nano SIM card/microSD card tray in the handset, and press it in straight all the way

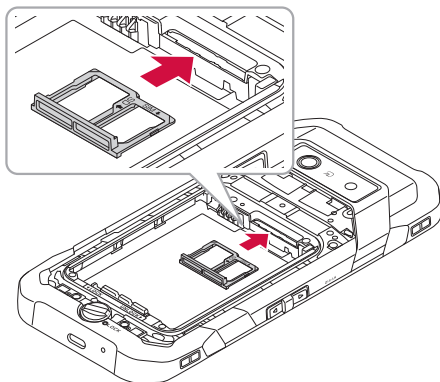

eSIM

The handset supports eSIMs, that contain personal information such as your phone number.

- Setting is required before using an eSIM (→P.63).
- Back up personal files saved on an eSIM to microSD card, computer, the cloud, etc. or make a separate note. DOCOMO is not responsible for any saved data that is lost.
- Refer to the NTT DOCOMO website for more information on eSIMs.

microSD card

You can save data on the handset to a microSD card or import data on a microSD card to the handset.

- Commercially available microSD cards up to 2 GB, microSDHC cards up to 32 GB, and microSDXC cards up to 1 TB can be used with the handset (as of Dec. 2023).
- Some commercially available microSD cards may not operate properly. For information on supported microSD cards, inquire with each microSD card manufacturer.
- Do not power off the handset or remove a microSD card immediately after inserting the microSD card in the handset (while writing information needed for handset operation) or while editing data on the microSD card. Data may be corrupted or the handset

may not work properly.

- Format unformatted microSD cards on the handset before use (→P.67). microSD cards formatted by PCs or other devices may not be used properly on the handset.
- Data saved on microSD cards from other devices may not be displayed or played on the handset. Some data saved on the microSD card from the handset may not be displayed or played on other devices.
- Back up data saved on the microSD card or otherwise store in another place. DOCOMO shall not be liable for any loss or change of saved data.
- microSDXC cards are supported by SDXC-compatible devices only. Installing a microSDXC card in a non-SDXC-compatible device may corrupt data saved on the card. Avoid installing.
- To use a corrupted microSDXC card again, format it on an SDXC-compatible device (all microSDXC card data will be erased).
- To copy data with a non-SDXC device, use a card compliant with the standards of the device being copied to/from (microSDHC card, microSD card, etc.).
- microSD card speed class can be up to a maximum of class 10.
- microSD card UHS speed class can be up to class 3.
- The speed class indicates microSD card performance, and does not guarantee the speed class performance for all operation.

Installing/removing a microSD card

- When installing/removing a microSD card, power off the handset and place it with its back up, and remove the back cover and battery pack (→P.20). After installation/removal, replace the back cover and battery pack (→P.19).

Installing a microSD card

- 1 Pull the nano SIM card/microSD card tray out straight

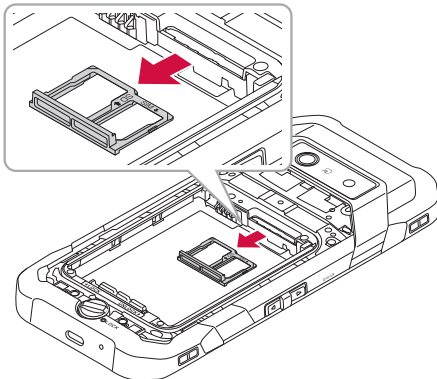

- 2 Set the microSD card in the nano SIM card/microSD card tray with the terminals (metal) facing down

- Make sure the microSD card is in the nano SIM card/microSD card tray securely.

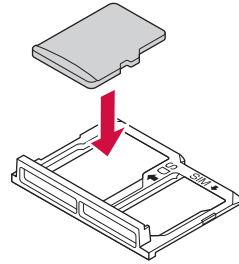

- 3 Insert the nano SIM card/microSD card tray in the handset, and press it in straight all the way

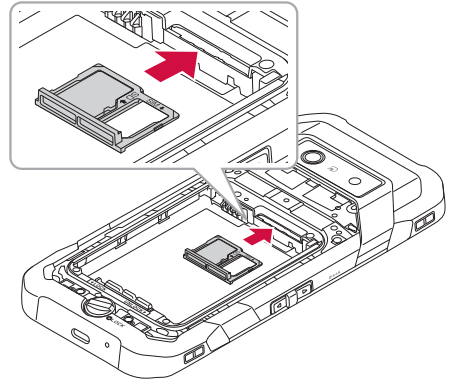

Removing a microSD card

- 1 Pull the nano SIM card/microSD card tray out straight

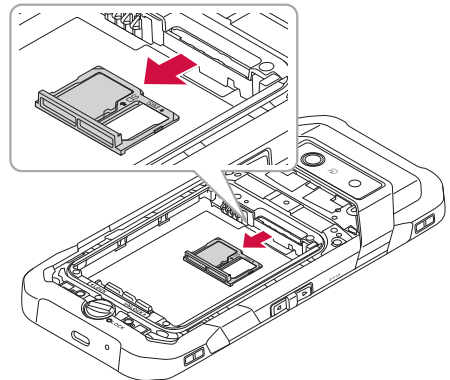

- Remove the microSD card from the nano SIM card/microSD card tray

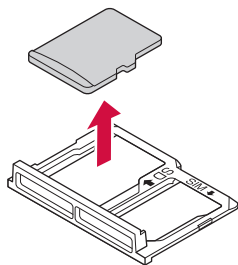

- Insert the nano SIM card/microSD card tray in the handset, and press it in straight all the way

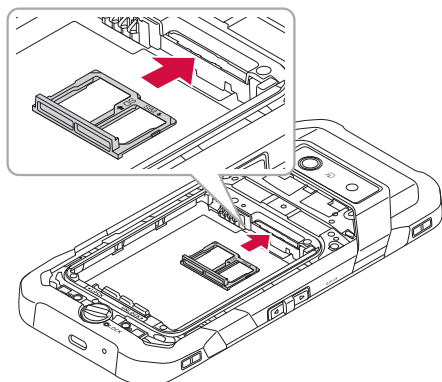

Charging

The battery pack is not fully charged at the time of purchase.

- Approximate charging time →P. 90

Usable time after fully charging (approximate)

The time that the handset can be used depends on the usage environment and condition of the battery pack.

- Approximate usable time →P. 90

Battery pack service life

- The battery pack is a consumable. Available time shortens with each repeated charge.
- Using apps, capturing video, etc. for a long period while charging shortens the life of the battery pack.
- Once available time is only about half of when it was purchased, it is approaching the end of its life. It is recommended to replace it soon. Depending on use, the battery pack may bulge near end of its usable life. There is no problem with the battery pack.



Internal battery life

- The internal battery in the handset is only used when swapping the battery pack while the handset is still powered on (→P.20). When the internal battery is approaching the end of its service life, a message is displayed when swapping batteries that it is deteriorating. It is recommended to replace it soon. To check the condition of the internal battery: In the home screen, [] ▶ [Settings] ▶ [Battery] ▶ [Battery swap] ▶ [Built-in battery health]



Charging

- The battery can also be charged with the handset powered on (while charging, [] appears on the battery icon).
- Do not charge for a long time with the handset left powered on. Leaving the handset powered on after charging is complete decreases the battery pack charge level. In this instance, an AC adapter (sold separately) or DC adapter (sold separately) charges the battery again. However, depending on when the handset is disconnected from the AC or DC adapter, the battery charge level may be low or the battery pack may only be usable for a short time.
- Leaving the handset unused for a long time even after charging is completed may decrease the battery level.
- If the battery has no charge when starting charging, the charging lamp may not light immediately. However, charging is in progress.
- If the handset displays no charge and cannot be powered on, charge the battery for a while.
- While charging, you may not be able to power on the handset even when the charging lamp is lit red. Charge longer and try powering on the handset again.
- Frequently recharging the battery when it still has charge may shorten its usable life. It is recommended to use up the battery to a certain level (e.g. after the battery level decreases) before charging.
- If the battery becomes warm, charging may stop even if the battery has not been fully charged. Charging resumes after the temperature lowers to an appropriate temperature.
- Check the NTT DOCOMO Online Shop for the latest adapter compatible with the handset.
<https://onlineshop.smt.docomo.ne.jp/options/search.html> (in Japanese only)

AC adapter and DC adapter

- Refer to the AC Adapter O8 (sold separately) or DC Adapter (sold separately) user guide.
- AC Adapter O8 accommodates from 100 to 240V AC.
- The shape of the plug for the AC adapter is for 100 V AC (for domestic use). To use an AC adapter of 100 to 240 V AC overseas, a conversion plug adapter compatible with your country of stay is required. Do not use a voltage converter for

overseas travel to charge the battery pack.

Adaptive Battery

You can restrict battery usage of infrequently used apps to reduce battery consumption.

- 1 In the home screen, [⊞] ▶ [Settings] ▶ [Battery]
- 2 [Adaptive Battery] ▶ Set "Use Adaptive Battery" to ON

Charging with an AC adapter

● Charging with AC Adapter O8 (sold separately) is described as an example.

- 1 Unfold the power plug of the AC adapter and plug into a household outlet

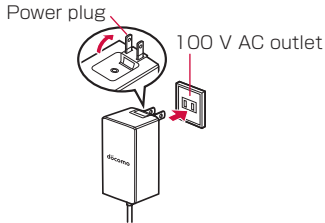

- 2 Insert the USB Type-C connector on the AC adapter straight into the handset USB Type-C connector terminal

- The USB Type-C connector can be inserted either upward or downward.
- Check that the charging lamp on the handset is lit red.
- The charging lamp flashes in blue for missed calls and notification messages also while charging.
- When charging is complete, the charging lamp changes to green.

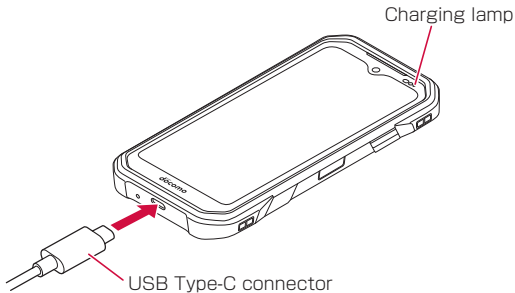

- 3 After charging is complete, unplug the AC adapter from the outlet
- 4 Remove the USB Type-C connector on the AC adapter from the handset USB Type-C connector terminal

Charging with a DC adapter

DC Adapter (sold separately) supplies power when charging from a vehicle accessory socket (12 V/24 V).

- For details on usage, see the DC Adapter user guide.

Charging with a PC

You can charge the handset by connecting the handset to a PC with a USB Cable A to C O2 (sold separately).

Connecting the handset and PC

- 1 Insert the USB Type-C connector on the USB Cable A to C O2 (sold separately) into the handset USB Type-C connector terminal without bending
- 2 Insert the USB connector on the USB cable A to C O2 into the USB connector on the PC without bending

NOTE

- Use a USB cable compatible with the handset. A connector with a different shape cannot be used.
- Using a USB hub or adapter plug may prevent normal use.
- Do not remove the USB cable A to C O2 while exchanging data with the PC. Data may be damaged.
- Connectable PC operating systems are Windows 10 and Windows 11 (Japanese versions)

Powering on/off

Powering On

- 1 Press and hold  (power button) until the screen turns on
 - When you power on the handset for the first time, make initial settings (→P.26).
- 2 Slide the start screen to the left to unlock the screen
 - The home screen is displayed.
 - For the method for unlocking the screen, see "Unlocking the screen" (→P.26).

NOTE

- It may take time for the handset to start up the first time it is powered on.

Powering off

- 1 Long-press  (power button) (at least 1 second)
 - The following menu items are displayed.

Emergency	Call an emergency number (110, 119, or 118) (→P.40).
Lockdown	Set the handset not to display notifications in the start screen, and not to unlock with Fingerprint Unlock or Face Unlock. <ul style="list-style-type: none"> The "Screen lock" for the start screen (→P.70) is set to "Pattern" / "PIN" / "Password".
Power off	Power off the handset.
Restart	Restart the handset.
Screenshot	Save the current screen as an image.
Battery swap	Swap the battery pack while the handset is powered on (→P.20).

2 [Power off]

Entering sleep mode

Place the handset in sleep mode to turn off the screen and prevent touchpanel operation as well as reduce battery consumption.

1 Press (power button)

- Press  (power button) again to exit sleep mode and turn on the screen.



NOTE

- To change the delay until handset enters sleep mode, in the home screen, tap  ▶ [Settings] ▶ [Display] ▶ [Screen timeout] and select the time delay.

Unlocking the screen

The start screen (lock screen) is displayed when the handset is powered on or exiting sleep mode.

1 Slide the start screen up

- The home screen, or the screen before entering sleep mode is displayed.
- If  is displayed at the top of the start screen, the "Screen lock" for the start screen (→P.70) is set to "Pattern" / "PIN" / "Password". After unlocking the security, the home screen is displayed.
- If the Smart Lock (→P.69) is temporarily unlocked while it is set,  is displayed at the top of the screen, and the screen is unlocked with the set method.
- If your face is registered with "Face Unlock", you can use Face Unlock to unlock the screen (→P.71).
- If a fingerprint is registered with "Fingerprint Unlock", you can use Fingerprint Unlock to unlock the screen (→P.70).

Initial settings

An initial settings screen appears the first time the handset is powered on. Follow the instructions on the screen.

- To skip settings, tap "Skip", "No thanks", etc. at each step, and follow the instructions on the screen.

1 [日本語(日本)] (Japanese (Japan)) ▶ [English] ▶ [United States] ▶ [Start]

- Tap "日本語 (日本)" to change the handset language.
- Tap "Emergency call" to call an emergency number (110, 119, or 118) (→P.40).
- Tap "Vision settings" to make user accessibility settings.
- Continue by following onscreen instructions to set items.
 - Connect to Wi-Fi
 - Copy apps & data
 - Google account settings
 - Google service settings
 - Setting information collection on usage for battery replacement
 - Protect your phone
 - Google Assistant settings
 - Google Pay settings

2 When the docomo initial settings screen appears, check the content and tap "Next"

- Continue by following onscreen instructions to set items.
 - Function Use Verification
 - d ACCOUNT
 - Easy bulk setting Safety and ease of use

3 Set other settings

- To skip settings, tap "No thanks".

4 When a description screen appears for the home screen, check the content and tap "Next"

- Continue by following onscreen instructions to set items.
 - my daiz settings
 - マイマガジン (My Magazine) settings

NOTE

- To use an eSIM for the first time and a nano SIM card is not installed in the handset, a prompt to connect to the mobile network is displayed. Tap "Download a new eSIM", and follow onscreen instructions to add SIM information to the eSIM (→P.63).
- Shown items may differ depending on your Google account or current settings.
- You can also change settings later.

Making Google account settings

A Google account is a user name and password to let you use Google services. Set a Google account on the handset to use Gmail exchange email, or use Google Play to download apps.

- 1 In the home screen, [⌘] ▶ [Settings] ▶ [Passwords & accounts] ▶ [Add account] ▶ [Google]

- Continue by following the instructions on the screen.

NOTE

- You can still use the handset even if you do not set a Google account, however, Gmail, Google Play, and other Google services will be unavailable.

Making d ACCOUNT settings

d ACCOUNT is an ID and password required to use d ACCOUNT services and d POINTs on smartphones, tablets, PCs, etc.

- 1 In the home screen, [⌘] ▶ [Settings] ▶ [docomo service/cloud] ▶ [d ACCOUNT setting]

- Continue by following the instructions on the screen.

Security codes used on the handset

Some functions for convenient use of the handset require security codes. In addition to a security code for handset operation, there are codes such as a network access code for network services. Use the different codes and get the most out of your handset.

■ Precautions about security codes

- Avoid setting security codes that are easy to guess, such as a birthday, part of a phone number, address/room number, "1111", and "1234". Keep a separate memo of security codes.
- Keep security codes private. If security codes are misused by others, DOCOMO shall not be responsible whatsoever for any resulting damages.
- If you forget your security codes, visit a docomo Shop with documentation showing you are the contracted subscriber (driver's license, etc.), the handset, and the nano SIM card. For details, contact the number listed on the last page.
- The PUK (Personal Unblocking Key) is indicated on the application (customer copy) you received when you subscribed at a docomo Shop. If you subscribed at a location other than a docomo Shop, contact the number listed on the last page.

d ACCOUNT password

d ACCOUNT is an account usable with docomo apps. You set an arbitrary code for your d ACCOUNT during your initial settings, but you can change the code at anytime (→P.27).

- For details on d ACCOUNT, refer to the NTT DOCOMO website.

Screen lock PIN/password

A security code for using the handset's screen lock (→P.70).

Network security code

A four-digit code required such as when verifying a subscriber's identity when visiting a docomo Shop, docomo information center, or "customer support", or when using network services. You set an arbitrary number when subscribing, and you can also change the number.

- For details on the network security code, refer to the NTT DOCOMO website.

SIM PIN

A nano SIM card/eSIM has a security code called the SIM PIN. It is set to "0000" when subscribing, but you can also change the number (→P.28).

The SIM PIN is a four- to eight-digit security code that needs to be entered for recognizing the user of the nano SIM card every time a card is inserted or when the handset is turned on to prevent unauthorized use of the nano SIM card/eSIM by a third party. Enter the SIM PIN to enable sending/receiving and handset operation.

- If inserting a nano SIM card that has been used in another device, use the previously set SIM PIN. It is

[0000] if the setting has not been changed.

- If you enter a wrong PIN code three times continuously, it is locked and the nano SIM card cannot be used. If the card becomes locked, enter the Personal Unblocking Key (PUK).

PIN Unblocking Key (PUK)

An eight-digit code for unlocking the handset if it becomes PIN-locked. You cannot change the code.

- If you enter the wrong key 10 times continuously, the nano SIM card/eSIM is completely locked. In this instance, contact the number listed on the last page.

Setting the SIM PIN

When a SIM PIN is set, a screen is displayed for entering the SIM PIN when the handset is powered on, to protect the handset from unauthorized access.

- 1 In the home screen, [⌘] ▶ [Settings] ▶ [Security] ▶ [More security settings] ▶ [SIM card lock]
- 2 [Lock SIM card]
- 3 Enter the current SIM PIN ▶ [OK]

Changing the SIM PIN

- 1 In the home screen, [⌘] ▶ [Settings] ▶ [Security] ▶ [More security settings] ▶ [SIM card lock]
- 2 [Change SIM PIN]
- 3 Enter the current SIM PIN ▶ [OK]
- 4 Enter the new SIM PIN ▶ [OK]
- 5 Enter the new SIM PIN again ▶ [OK]

NOTE

- The SIM PIN can be changed only when the SIM card lock is set.

Basic Operations

Basic operations

Using the display (touchscreen)

Touch the display (touchscreen) directly to operate the handset.

Cautions when using the display (touchscreen)

- Touch the touchscreen lightly with your fingers to operate. Do not operate with a pen, pencil, or other pointed object. In addition to not operating correctly, it may scratch or damage the display.
- The touchscreen may not operate or may misoperate in the following instances.
 - Stickers or commercially-available sheets are adhered to the display
 - The display is soiled
 - Operation with fingernails
- If carrying in pocket or bag, metal or other conductive objects that are close to the touchscreen may cause it to misoperate.

NOTE

- The handset can still be touch-operated even when the display or your hands have moisture or you are wearing gloves (wet touch/glove touch mode).
- Although touch operation wearing gloves is possible, the thickness or material of the gloves may make touch operation difficult.
- If moisture on your fingers or gloves prevents touch operation, wipe away moisture.
- If gloves with poor-fitting fingers prevent touch operation, make sure the pads of your fingers touch the display.
- Handset gives priority to bare-finger operation if operated both while wearing gloves and with bare fingers.

Tap

Contact the display lightly and briefly.

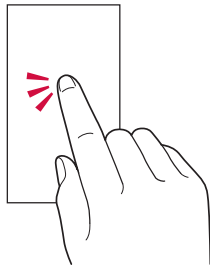

Touch and hold

Hold finger on an item.

- Set the time for touch and hold operation (→P.68).

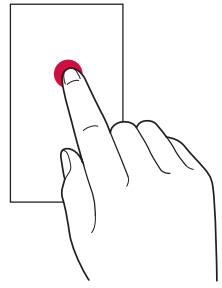

Slide/swipe

Slide your finger in the desired direction when screen contents are partially hidden.

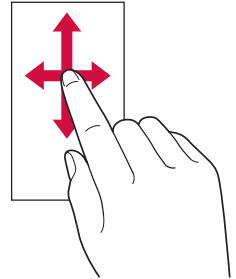

Flick

Flick your finger briskly on the screen up, down, left, or right.

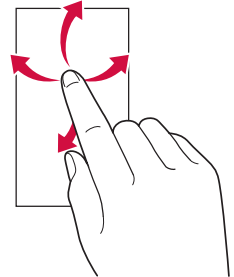

Zoom

Touch the display lightly with two fingers, then widen (zoom in) or close (zoom out) fingers.

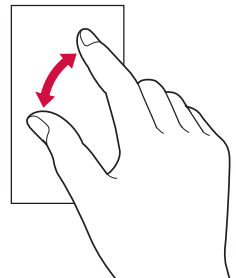

Drag

Touch the screen lightly and slide in the desired direction to move an item or icon.

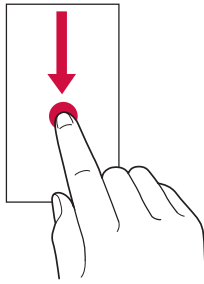

Basic gesture navigation

When navigation is displayed, you can simply slide/flick the touchscreen to display the home screen, go back one previous screen, etc.

Operation	Description
Flick the bottom of the screen up	Shows the home screen.
Slide inward from right or left edge of the screen	Go back one previous screen.
Slide the bottom of the screen up a little, and release where finger stopped	RECENTS (task manager) is displayed (→P.35).
Slide the bottom of the screen to the right	Change to recently used apps.

NOTE

- If navigation is not displayed at the bottom of the screen when playing back photos or video, tap the screen to display it.

Direct keys

Press (direct key Left)/ (direct key Right) to use a preset app.

Setting the direct keys

- 1 In the home screen, ▶ [Settings] ▶ [Direct keys] ▶ [Direct key Right]/[Direct key Left]
 - Select the direct key to set.
- 2 [Single press] / [Double press] / [Press and hold]
 - Select the operation to set.
 - Set "Answer and end call" to ON and long-press either direct key Left/Right to answer/end a call.
 - Set "Wake up device" to ON to enable use of the direct keys even while in sleep mode.
- 3 Tap the app to set
 - If you tap "Do nothing", pressing the direct key Left/Right does not activate the assigned app.

NOTE

- If an app set to either direct key Left/Right is uninstalled, the direct key Left/Right becomes set to "Do nothing".

Switching settings

When a toggleswitch appears next to a setting option, tap to switch the setting ON/OFF.

Example: Network preferences

The setting is set ON with , and OFF with .

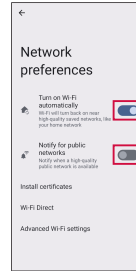

Switching automatically between vertical and horizontal screen display

The handset can switch automatically between vertical and horizontal screen display according to its orientation.

- 1 In the home screen, ▶ [Settings] ▶ [Display] ▶ Set "Auto-rotate screen" to ON

NOTE

- Operate the handset held upright. The screen may not change if operating the handset held flat.
- Depending on the current screen, the screen may not change regardless handset's orientation or settings.

Setting Manner mode

Set handset sound to avoid disturbing others when in public.

- 1 Press the (volume up button) or (volume down button)
 - The Manner mode icon and volume adjustment bar appears.
- 2 [Vibrate] / [Mute] / [Drive] / [OFF] ▶ Tap the Manner mode to set
 - Settable Manner mode types are the following.
 - OFF: set Manner mode OFF.
 - Vibrate: Ringtones and other handset sounds are muted; handset vibrates for incoming calls/messages, etc.
 - Mute: Ringtones and other handset sounds are muted; handset does not vibrate for incoming calls/messages, etc.

- Drive: Ringtones and other handset sounds are muted; handset does not vibrate for incoming calls/messages, etc. When a call arrives, auto answering activates and a message plays to indicate that you are driving.

NOTE

- Even while in Manner mode, camera shutter sound and video recording tones still sound.
- Adjusting the volume of "Ring & notification volume" (→P.67) while in Manner mode exits Manner mode.
- Press (volume up button)/ (volume down button) to adjust the (media) volume of video, radio, etc. while in Manner mode.

Capturing the displayed screen

Save the current screen as an image (screenshot).

- 1 In screen to capture, press (power button) and (volume down button) at the same time

NOTE

- Some screens may not be savable depending on the current screen.
- Alternatively, long-press (power button) (at least 1 second) ▶ [Screenshot] to save a current screen as an image.

Selecting an app to use

When several apps are available for a specific operation, such as sending mail or displaying an image, an app selection screen is displayed.

Example: selecting an app to send mail

- 1 In the home screen, ▶ [docomo phonebook] ▶ Select the contact ▶ Tap the mail address to use
 - An app selection screen for sending is displayed.
- 2 Select the app ▶ [Just once]/[Always]
 - To check the app being used every time, select "Just once". To always use the same app, select "Always".
 - After selecting "Always", the app selection screen is no longer displayed the next time using the same operation.
 - After selecting "Just once", a screen with the app appearing selected is displayed the next time using the same operation. To use a different app, select an app from "Use a different app".

NOTE

- "Always" set for an app can be canceled as follows. In the home screen, ▶ [Settings] ▶ [Apps] ▶ [See all XX apps] ▶ Tap the app with "Always" set ▶ [Open by default] ▶ [Open supported links]

Setting app permissions

When first activating a handset app or function, a screen requesting access permission is displayed. If confirmation appears, check the content and tap "ALLOW"/"DON'T ALLOW".

- "ONLY THIS TIME", "WHILE USING THE APP", etc. are displayed for some apps/functions.

Example: activating schedule for the first time

- 1 Confirmation screen for access permission ▶ [NEXT SCREEN] ▶ [ALLOW]/[DON'T ALLOW]
 - Normally, tap [ALLOW] to permit usage of the function.
 - For several functions, continue in the same way.

Setting permission for individual apps/functions

■ To set permission for an individual app

- 1 In the home screen, ▶ [Settings] ▶ [Apps]
- 2 [See all XX apps] ▶ Select the app ▶ [Permissions] ▶ Select the function ▶ [Allow]/[Don't allow]

■ To set permission for an individual function

- 1 In the home screen, ▶ [Settings] ▶ [Privacy]
- 2 [Permission manager] ▶ Select the function ▶ Select the app ▶ [Allow] / [Don't allow]

NOTE

- Some apps/functions may be unavailable or usage of functions may be restricted unless permission is allowed.
- A description of the permission may be displayed for some apps/functions. Confirmation may be displayed several times or may be displayed differently in some instances. Check the content and follow the instructions on the screen.
- Descriptions of confirmation are sometimes abbreviated in this instruction manual.

Battery saver

Control battery consumption when the battery saver is ON.

- 1 In the home screen, ▶ [Settings] ▶ [Battery] ▶ [Battery Saver] ▶ [Use Battery Saver] ▶ [TURN ON]

Character entry

Use onscreen keyboards for text entry. Tap the entry field in a screen for text entry such as when registering a contact or creating mail to display an onscreen keyboard.

Switching entry methods

You can switch to a method other than the method set at time of purchase.

- Available when another method is installed beforehand.

- In the home screen, [Settings] ▶ [System] ▶ [Languages & input] ▶ [On-screen keyboard] ▶ Select the entry method

Onscreen keyboard

The following keyboards are available on the handset.

12 キー (12-key)	Keyboard laid out the same as common mobile phones. Tap a key to cycle through characters (toggle entry). Flick entry is also possible.
QWERTY	Keyboard laid out the same as common computer. The displayed character on a key is entered when tapped. Enter Japanese in "romaji".
手書き (Handwriting)	Keyboard for entering handwriting.
GODAN	Keyboard designed specifically for entering romaji.
五十音 (Gojuon)	Keyboard laid out in 50-syllable gojuon order.

Entering characters

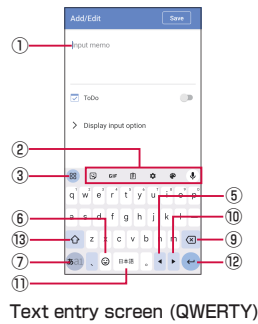
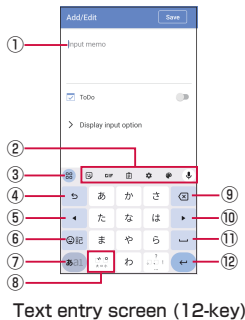

- Character entry area**
- Toolbar**
 - Enter text and a conversion candidates list is displayed.
 - Tap "✓" to enlarge the display area for the candidates list. To return to the original display, tap "∧".
- Tools key**
 - All tools are displayed. Rearrange tools.
- Reverse-toggle/back key**
 - Displayed in 12-key keyboard. Cycle through characters assigned to the same key in the order reverse to normal.
- Cursor key (L)**
 - Move the cursor left.
- Emoji/emoticon key**
 - Display the emoji and emoticon list.
- Entry mode switch key**
 - Cycle through character types: "hiragana/kanji" → "alphabet" → "numbers". Touch and hold to display keyboard settings or set one-handed mode.
- Upper case/lower case key**
 - switch upper/lower case, one-/two-byte characters, or enter dakuten/han-dakuten.
- Keyboard switch key**
 - Displayed when several keyboards are set. Switch keyboards.
- Delete key**
 - Delete a character before the cursor position.
- Cursor key (R)**
 - Move the cursor right.
- Space key**
 - Enter a space. When entering "hiragana/kanji", tap the displayed "変換" to display characters in conversion candidates list in order.
- Line break/confirm key**
 - Confirm characters/enter a line break, move to a next item, etc.
 - Keys such as ↵, ⏎, and ⏏ are displayed in some screens, and work according to each screen for text entry.
- Shift key**
 - Displayed in "QWERTY" keyboard. Switch between small letters, capitalize only one letter, and all capitals.

NOTE

- Some types of characters may not be enterable depending on the screen, app, etc. being used.

Toggle entry

Tap the same key in "12-key" keyboard consecutive times to enter characters, numbers, and symbols assigned to that key.

To continue entering a same character, etc. assigned to a key, tap "▶" before entering the character.

Example: entering "あお"

- 1 Tap "あ" 1 time ▶ [▶] ▶ Tap "あ" 5 times

Flick entry

In the "12-key" keyboard, flick keys up, down, left, or right to enter characters. Touch a key and enterable candidates are displayed. Still touching the key, flick in the direction of the character to enter and the character is entered.

Example: entering "お"

- 1 Touch "あ" ▶ Flick down



Editing text

Cutting/copying text then pasting

Cut, copy, and past text.

- 1 Text entry screen ▶ Touch and hold text ▶ Drag "●"/"⌘"/"⌘" to select the range
- 2 [Cut]/[Copy]
- 3 Tap the position where to past text to move the cursor ▶ [●] ▶ [Paste]

Personal dictionary

Register frequently used words, etc. to display them in the conversion candidates list when you start typing them in.

- 1 Text entry screen ▶ [⚙] ▶ [Dictionary] ▶ [Personal dictionary]
- 2 Tap the language to register
 - A word list screen is displayed.
- 3 [+]
- 4 Enter words/reading

NOTE

- To delete a registered word, in the word list screen ▶ Tap the word to delete ▶ "🗑".

Setting character entry

Make key operation settings including confirmation tones, vibration, etc. with iWnn IME.

- 1 Text entry screen ▶ [⚙]
- 2 Set each item

Languages	Set onscreen keyboards per each language.
Preferences	Set key arrangement, keyboard layout, key operation, etc.
Theme	Change the look of onscreen keyboards.
Text correction	Make settings for entry candidates and automatic text correction.
Glide typing	Set glide entry to allow entry of words by sliding between letters when entering English in QWERTY.
Voice typing	Make voice entry settings.
Clipboard	Enable recently copied text and images to appear where the toolbar is located, etc.
Dictionary	Dictionary →P.33
Emojis,Stickers & GIFs	Make settings for a rapid access line for emoji candidates, predictive content search, etc.
Share Gboard	Share Gboard to other users.
Privacy	Make privacy settings.
Rate us	Rate Gboard.
About	Terms of use, etc. for Google apps are displayed.
Help & feedback	Google help is displayed.

Notification LED

Charging lamp

Check the charge state and notifications while charging with the notification LED (charging lamp).

LED color and operation	Notification
Lit red	Indicates charging.
Flashing red	Indicates charging required.
Lit green	Indicates charging has completed.
Flashing blue	Indicates missed calls and notification messages.
Flashing white	Indicates a new +Message.

NOTE

- When using "Battery swap" (→P.20), notification LED colors, operation, and nature of notifications are different from normal.

Screen display and icons

Status bar

Notification icons to alert you to notifications and status icons for checking handset status appear in the status bar.

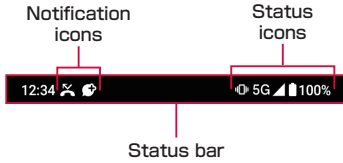

Main status icons

	Battery level
	Charging required
	Charging
	Battery saver set
	Battery Care Mode
	Signal level (5 levels)*1
	Voice service unavailable
	Data service unavailable*2
	Both voice and data service unavailable
	5G available*3
	4G (LTE) available*3, 4
	International roaming
	Airplane mode
	Wi-Fi connected (5 levels)*3
	Wi-Fi connected, no Internet access*3
	Manner mode (Vibrate)
	Manner mode (Mute)
	Manner mode (Drive)
	Do Not Disturb mode
	Bluetooth device connected
	Wi-Fi tethering
	Talking using speaker
	Auto answering set
	GPS positioning
	VPN connected
	Data Saver set
	Microphone in use
	Camera in use

*1 If using a nano SIM card and an eSIM at the same time, two signal statuses (nano SIM card on left, eSIM on right) are displayed.

*2 The signal status is displayed for the data service that is given priority when using a nano SIM card and an eSIM at the same time. is displayed for the non-priority SIM.

*3 During communication, is displayed at left of the icon.

*4 always appears while the handset is connected by LTE.

Main notification icons

	New mail
	New +Message/new SMS
	New Gmail
	Missed calls
	Dialing / talking / call arriving
	New auto answer message
	New voicemail
	Sending/uploading data
	Receiving/downloading data
	Notification for error, alert, etc.
	Using radiko+FM
	Alarm sounding / snoozing / upcoming alarm
	Schedule/memo note notification
	Calendar notification
	Software update available
	Settings notification
	Available handset memory low
	Unread notifications

Notifications panel

Display the notifications panel to check details of notifications or activate corresponding apps.

1 Slide the status bar down

- The notifications panel is displayed.
- Slide the notifications panel down for hidden icons, screen brightness adjustments slider, settings menu icon, power menu icon, and status of running applications.

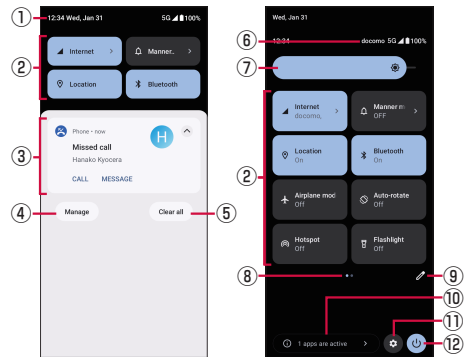

Notifications panel screen

Quick Settings panel completely open

1 Date and time display

2 Quick Settings panel

- Set frequently used functions ON/OFF, etc.
- When the Quick Settings panel is completely open, flick the display area left/right to switch pages.

3 Notification area

- Check details of handset status and notifications. Some information allows you to tap and activate a corresponding app.

- ④ **Manage**
 - Make settings for notifications from apps.
- ⑤ **Clear all**
 - Tap to delete all notifications. Some notifications cannot be deleted.
- ⑥ **Carrier name**
 - The name of the connected carrier is displayed.
- ⑦ **Brightness**
 - Drag the slider left/right to adjust screen brightness.
- ⑧ **Indicator**
 - Displays the total number of Quick Settings panel pages and your current position.
- ⑨ **Edit**
 - Rearrange Quick Settings panel, and add/delete buttons.
- ⑩ **Status of running apps**
 - Tap to display the status of running apps.
- ⑪ **Settings**
 - Activate the "Settings" app.
- ⑫ **Power menu**
 - Use a menu the same as after long-pressing  (power button) at least 1 second (→P.25).

NOTE

- You can also slide the screen from the bottom to the top to hide the notifications panel.
- To delete individual notifications, flick a notification to delete to the left or right. Some notifications cannot be deleted.

Task manager

Slide the screen from the bottom to the top to display thumbnails of recently used apps to check, activate, switch between, and end apps.

- ① **Slide the bottom of the screen up, and release where finger stopped**
 - Show thumbnails of recently used apps.
 - Flick left/right to toggle thumbnails.
 - Flick a thumbnail up to delete a thumbnail and exit an app. To delete all thumbnails, flick to the right, and tap "CLEAR ALL" displayed at the left edge of the screen.

NOTE

- When "App pinning" (→P.69) is set to ON, tap the icon above the app ▶ [Pin] ▶ [GOT IT] to pin the screen, and no operations other than the current app cannot be used.
- While an app is pinned, answering calls and location searching by a third party are not possible. Also, other apps may not operate properly, or notifications may not be displayed.
- To unpin an app, slide the bottom of the screen up and hold.

Multiwindow

Use two apps at the same time, split in top and bottom windows.

- ① **Slide the bottom of the screen up, and release where finger stopped**
- ② **Tap the icon above the app to split ▶ [Split top]**
 - The screen splits into top and bottom, and the selected app appears in the top.
- ③ **Tap the app to display at the same time**
 - The tapped app appears in the bottom of the multiwindow.
 - Drag "" in the middle of the screen to the top/bottom of the screen to exit the multiwindow.

NOTE

- The multiwindow may be unavailable with some apps.

Home Screen

Switching the Home app

Switch the Home app.

- At time of purchase, you can use "docomo LIVE UX" and "Simple Home".

- 1 In the home screen, [⊞] ▶ [Settings] ▶ [Switch home app] ▶ Select the Home app

docomo LIVE UX

Home app from DOCOMO. Allows you to customize the home screen intuitively.

For details on docomo LIVE UX, in the home screen, [⊞] ▶ [⋮] ▶ Refer to [Help], or visit the NTT DOCOMO website below.

https://www.docomo.ne.jp/service/live_ux/index.html (in Japanese only)

Home screen layout

Activate apps and use widgets in the home screen. All apps are saved to the app list, and icon shortcuts to apps are arranged in the home screen.

- Flick the display home screen left/right to switch pages.
- When an app has a new notification, a dot or number may be displayed at the top right of the app icon or folder.



Home screen

1 Widget

- Activate widgets (Google Search).
- You can touch and hold some widgets for a shortcut menu and use specific operations.

2 App icon shortcuts

- Tap to activate apps.
- You can touch and hold shortcuts for a shortcut menu and use specific operations or check app information. If "=" is displayed, touch and hold then drag to any location to add a shortcut for a specific operation to the home screen.

3 Indicator

- Indicates the total number of home screen pages and your current position.
* Displayed only when flicking the screen.

4 Dock

- Always displayed, even when changing home screen pages.

5 Customize area

- Place apps, widgets, folders, etc.

6 Machi-Chara

- Tap to ask questions interactively.

7 Folder

- App icons, etc. are saved here.

8 App list button

- Displays all apps. Also, search for apps (→P.37).

Managing the home screen

Moving app icons, etc.

- 1 Touch and hold the app icon, widget, etc. to move in the home screen
- 2 Drag it to the new location
 - Drag it to the edge of the home screen to move it to the next page.

Adding app icons

- 1 In the home screen, [⊞]
- 2 Touch and hold the app icon to add to the home screen
- 3 [Add to home screen]
 - You can several copies of the same app icon.

Deleting app icons from the home screen

- 1 Touch and hold the app icon, widget, etc. to delete from the home screen
- 2 Drag it to "Remove" at the top of the screen, or tap "Remove from Home screen" at the top of the app icon
 - This deletes app icons from the home screen, but this does not uninstall apps themselves.

Deleting widgets, etc.

- 1 Touch and hold the widget, etc. to delete from the home screen
- 2 Drag it to "Remove" at the top of the screen

Uninstalling apps

- 1 Touch and hold the app icon to uninstall from the home screen
 - To uninstall an app in a folder, tap the folder, then touch and hold the app icon to uninstall.
- 2 Drag it to "Uninstall" at the top of the screen ▶ [OK] , or tap "Uninstall" at the top of the app icon ▶ [OK]
 - "Uninstall" is not displayed if an app cannot be uninstalled.
 - Once an app is uninstalled, it no longer appears in the app list.

Changing the name of a folder

- 1 In the home screen, select the folder
- 2 Tap the folder name
- 3 Enter the folder name
 - Tap "✓" displayed on the keyboard.

Home screen settings

- 1 Touch and hold an area of the home screen with no app icons, etc. ▶ [Home settings]
- 2 Select an item

Notification dots	Set the dot indicating new notifications for apps ON/OFF.
Add app icons to home screen	Select either to add an app icon automatically in the home screen, or to display the app only in the app list when installing a new app. * Pre-installed apps are displayed at the end of the app list by default.
Add home settings icon	Enable the "Home settings" icon to be displayed in the home screen.
Wallpapers	Change the wallpaper in the home screen and lock screen.
Machi-Chara	Set Machi-Chara ON/OFF, or make Machi-Chara settings such as changing characters.
Display my daiz NOW	Set display of my daiz NOW displayed at the leftmost of the home screen.
My Magazine	Set flick-to-activate for マイマガジン (My Magazine) ON/OFF.
Get started	Check a tutorial on the home screen.
Help	Check how to use the home screen in detail.

App list screen

Tap "☰" to display. In the app list screen, you can rearrange apps, create folders, and search for apps by the name of the app.



- 1 App search bar
 - Tap, then enter the search text for an app

- 2 All apps
 - All installed apps on the handset are displayed.
Tap to activate apps.

Managing the app list screen

Moving app icons, etc.

- 1 Touch and hold the app icon to move in the app list screen
- 2 Drag it to the new location

Changing the name of a folder

- 1 In the app list screen, select the folder
- 2 Tap the folder name
- 3 Enter the folder name
 - Tap "✓" displayed on the keyboard.

マイマガジン (My Magazine)

A reader-friendly news app that brings you everything from articles and what's newsworthy in the world to articles matched to each user's hobbies and tastes, as well as bargain coupons and the perfect comic to fill in some free time. Your read articles and profile information shape the trend of articles toward your preferences the more you read. You can customize settings, such as displayed genres, notifications, horoscope sign, and region for weather forecast.

Article layout

- 1 In the home screen, []
 - If an initial setup screen is displayed, tap "規約に同意してはじめる".
 - An article list screen of categorized genres is displayed.
 - Flick left/right to switch genres.
- 2 Tap articles to read
 - Tap an article in the article list screen to read the information in the article.

my daiz NOW

This service brings you convenient information matched to your preferences and behavior. Check useful lifestyle information such as weather, train and traffic information, dining out information, etc.

Screen layout

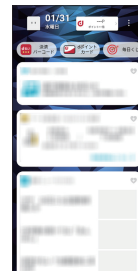

1 Flick the home screen right

- Slide up/down to change displayed cards.
- Flick left to return to the home screen.

2 Tap cards to read

- Tap a card to view information in more detail.
- Tap my daiz (character) at the top left of the screen to ask questions interactively.

Display settings

1 Touch and hold an area of the home screen with no app icons, etc. ▶ [Home settings]

2 Set "Display my daiz NOW" to OFF

Home app information

Check information such as the version of docomo LIVE UX.

1 In the home screen, [⌘] ▶ [⋮]

2 [About]

- When an update for docomo LIVE UX is available, "Update now" is displayed in the app information screen. Tap to update docomo LIVE UX.

Simple home

The Simple home screen is comprised of several screens. Swipe/flick the screen to the left or right to switch between screens.



1 Widget

- Activate widgets (Google Search).
- The date/time is displayed.
- You can touch and hold some widgets for a shortcut menu and use specific operations.

2 App icon shortcuts

- Tap to activate apps.
- You can touch and hold shortcuts for a shortcut menu and use specific operations or check app information. If "=" is displayed, touch and hold then drag to any location to add a shortcut for a specific operation to the home screen.

3 Indicators

- Indicates the total number of home screen pages and your current position.

App list

Apps installed at the time of purchase are as follows.

- Some apps allow you to check a Help for functions and operation.
- Some apps require a separate application (paid).
- installed apps are as follows.

App	Description
+Message	Exchange text messages using cellphone/smartphone numbers as addresses. In addition to the text, send images, videos, stamps, etc.
Chrome	Browse webpages.
dポイントクラブ (d POINT Club)	Check, save, and use d POINTs.
dメニュー (dmenu)	Shortcut app to "dmenu". A portal site allowing access to a wide range of contents and services from DOCOMO.
Files	Look for files such as images, videos, music, and downloaded files.
Gmail	Use Google's e-mail service and e-mail by general providers.
Google	Search the handset and websites using keywords.
Google TV	Rent as well as enjoy movies, etc.
iDアプリ (iD appli)	App for using the "iD" electronic money provided by DOCOMO. You can pay by holding an Osaifu-Keitai in which "iD" is set over scanning devices at stores.
Keep Notes	Edit memo notes.
Meet	App for video calling and telephone conferencing.
my daiz	This service notifies you with weather information and train delays matched to your departure, and allows you to ask questions interactively. Brings you the information you want and when you need it.
OfficeSuite	View Word, Excel, and other files.
Play Store	Download and purchase apps, games, etc.
radiko+FM	Connect to the Internet to listen to Internet radio broadcasting.
YouTube	Play videos on YouTube as well as search, upload, etc.
YT Music	Enjoy a broad range of music contents including official albums, music videos, remixes, covers, and recordings of live concerts.
Anshin Security	In addition to free anti-virus functions, security for harmful sites, hazardous Wi-Fi, nuisance calls, etc. and dark web monitoring are available.
Osaifu-Keitai	Display a list of already-registered Osaifu-Keitai compatible services with this app. Register recommended services, and check balances and points saved with registered services.

App	Description
Osusume Apps	Check apps and services that are recommended based on your usage.
Camera	Take still images and videos.
Calendar	Save and manage events and reminders.
Safety	Use functions for sharing emergency situations, checking safety of others, etc.
Disaster kit	You can use "Disaster Message Board", early warning "Area Mail", "All Areas Disaster and Evacuation Information", and "Recovery Area Map".
Schedule	Create and manage a schedule, and allows you to share information with a memo app.
スマホ診断 online (Smartphone diagnosis online)	You can perform a diagnosis anytime and anyplace if you think the handset may be malfunctioning, such as the battery depleting soon or inability to use Osaifu-Keitai. Suggested remedies and how to submit applications are shown based on the result of the diagnosis.
Settings	Make handset settings.
Data Copy	Migrate data when changing to a new device, or use a microSD card to back up and copy back data.
データ保管 BOX (Data Storage BOX)	Use Data Storage BOX. Upload files you want to save to the cloud and manage them.
Calculator	Calculate with arithmetic operations.
Phone	App for phoning and making call settings (→P.40).
Clock	Use alarms, world clocks, a timer, stopwatch, etc.
docomo phonebook	Contacts app from DOCOMO. Contacts data from your d ACCOUNT can be managed in the cloud.
docomo mail	You can send and receive mail using a DOCOMO mail address (@docomo.ne.jp). With a d ACCOUNT, you can use the same email address across several devices such as the handset and a PC browser to send, receive, and view email.
Drive	View and edit files saved to Google Drive .
Instruction Manual	An instruction manual for the handset. Activate functions directly from descriptions.
Barcode Scanner	Use a barcode scanner scan several barcodes at once, and scan several barcodes in a row.
Photos	Display/edit taken still photos and videos, and back them up to Google online storage .
マイマガジン (My Magazine)	A free and reader-friendly news app that brings you news and what's newsworthy.

App	Description
Maps	Display your current location and search routes to destinations.
Memo	Create and manage memos, and allows you to share information with a schedule app.

NOTE

- Some apps must be downloaded and installed. Packet communication charges are required separately for downloading apps.
- Some apps registered at the time of purchase can be uninstalled. You may be able to download an app you have uninstalled again from "Play Store" (→P.55) or other venue.

Phone/Contacts

Making a call

- 1 In the home screen, [📞] ▶ [DIALPAD]
 - A number entry screen is displayed.
- 2 Enter the phone number
 - Tap "✕" to delete one digit in the number.
- 3 [📞]
- 4 When the call ends, [📞]
 - If a screen for "Record late" (→P.44) is displayed, follow the onscreen instructions.

NOTE

- With VoLTE, you can enjoy high-quality calling. To use VoLTE, both your and the other party's handsets must meet the following requirements.
 - Be models compatible with VoLTE
 - Be in an area where VoLTE is available
 - "Preferred network type" must be "5G/4G/3G/GSM" or "4G/3G/GSM" (→P.81)
- With VoLTE (HD+), you can enjoy calling with higher-quality sound than VoLTE. To use VoLTE (HD+), in addition to conditions for using VoLTE, both your and the other party's handsets must support VoLTE (HD+).
- If using a nano SIM card and an eSIM at the same time, you can set the SIM to use when making a call (→P.63).

Entering touch-tone signals

When using services in which you are required to enter numbers additionally during a call, such as a bank balance inquiry or ticket reservation, enter a pause (,)/wait (;) after entering the phone number to send an additional number added to the main phone number.

Using an automatic pause (,)

Once the call connects, the added number will be sent automatically.

- 1 In the home screen, [📞] ▶ [DIALPAD]
 - A number entry screen is displayed.
- 2 Enter the phone number
- 3 [:] ▶ [Add special No.] ▶ [Add pause(,)]
- 4 Enter the phone number

Using a manually entered pause (;)

After dialing in the main phone number, confirmation appears for sending an additional number.

- 1 In the home screen, [📞] ▶ [DIALPAD]
 - A number entry screen is displayed.
- 2 Enter the phone number
- 3 [:] ▶ [Add special No.] ▶ [Add wait(;)]
- 4 Enter the phone number

Emergency calls

Emergency call	Phone number
Police	110
Fire and ambulance	119
Marine emergency	118

NOTE

- Calls connect to emergency service within Japan only using VoLTE (LTE network).
- The handset supports "emergency call location notification".

When you make a call to an emergency number such as 110, 119, or 118, the location dialed from (location) is automatically sent to the agency that has received the emergency call (e.g. the police). Depending on your location and the signal reception, the agency that has received the emergency call may not be able to confirm the exact location.

If you are not sending your caller ID by calling with "184" added or other means, your location information and phone number are not sent. However, if the agency that has received the emergency call considers your location information and phone number necessary, such as in a life-threatening situation, the agency can retrieve your accurate location by GPS and phone number regardless of your settings.

In addition, the area/timing at which that "emergency call location notification" service is introduced depends on the current preparation of each agency that receives emergency calls.
- In Japan, you cannot call to an emergency number (110, 119, or 118) when a nano SIM card is not inserted, an eSIM is not installed, while the SIM PIN is locked, or from the PUK (PIN Unblocking Key) entry screen.
- When calling 110, 119, or 118 from your handset, the police or fire department may return your call for verification purposes. State that you are calling from a mobile phone, and give your phone number and exact present location.

Remain stationary to ensure that the call is not disconnected while you are on the line, and keep the handset turned on to receive calls for approximately 10 minutes afterwards.
- Depending on the region, calls to the local police or fire department may not be made.
- When you make a call to an emergency number (110, 119, or 118) while reject call settings are set, settings are set to OFF.

International call (WORLD CALL)

WORLD CALL is an international calling service available from DOCOMO devices in Japan. For details of WORLD CALL, refer to the NTT DOCOMO website.

- 1 In the home screen, [📞] ▶ [DIALPAD]
 - A number entry screen is displayed.
- 2 + (touch and hold "0") ▶ Enter the country code ▶ Enter the area code (city code) ▶ Enter the other party's phone number

NOTE

- As for region codes (area codes) that begin with "0", omit the first "0" when entering. Some countries, such as Italy, require a first "0".

Answering a call

- 1 When a call arrives, the ringtone sounds and the call-arriving screen is displayed

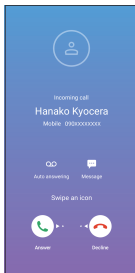

- 2 In the call-arriving screen, slide "📞" to the right
- 3 When the call ends, [📞]

NOTE

- If using a nano SIM card and an eSIM at the same time, the SIM to which the call is arriving at is displayed.

Answering a call while the screen is on

When a call arrives while a screen other than the lock screen is displayed, a new call notification is displayed. You can use the notification to answer the call.

- 1 When a call arrives, a new call notification is displayed at the top of the screen
- 2 [ANSWER]
 - Tap the new call notification to display the call-arriving screen.

Rejecting arriving calls

- 1 In the call-arriving screen, slide "📞" to the left
 - When a call arrives while a screen other than the lock screen is displayed, tap the new call notification or "DECLINE" in the call-arriving screen.

Answering with auto answering

Even when auto answering is not enabled beforehand, you can activate it manually.

- Auto answering →P.42
- 1 In the call-arriving screen, [Auto answering]
 - 2 [RECORD]

Sending messages

Reject an arriving call and send a selected message as SMS to the caller.

- 1 In the call-arriving screen, [Message]
- 2 Tap the message to send

Displaying the call-arriving screen from the notifications panel

The call-arriving screen can also be displayed from the notifications panel if closed, etc.

- 1 Slide the status bar down when a call is arriving
- 2 Tap the notification for "Incoming call"
 - The screen changes to the call-arriving screen.

Operations during a call

You can use operations such as hands-free calling and adjusting the volume during a call.

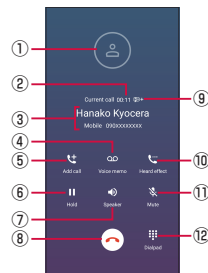

- 1 Other party's image
- 2 Call time
- 3 Other party's name and number
- 4 Voice memo/Stop recording
 - Start/end recording of a "Voice memo" (→P.43).

- ⑤ **Add call**
 - Make a call to another party.
- ⑥ **Hold/Unhold**
 - Place a call on hold/take a call off hold.
- ⑦ **Speaker**
 - Switch hands-free calling to ON or OFF.
- ⑧ **End call**
- ⑨ **HD/HD+**
 - Displayed during high-quality calls.
- ⑩ **Heard effect**
 - Adjust how the other party sounds.
- ⑪ **Mute/Unmute**
 - Set yourself to be unheard to the other party.
- ⑫ **Dialpad**
 - A dial entry screen is displayed.

NOTE

- If using a nano SIM card and an eSIM at the same time, the SIM being used is displayed during the call.
- Note the following when using hands-free calling.
 - When calling outdoors, in a location where surroundings are noisy, or where the sound echoes loudly, use an earphone/microphone.
 - If the sound cracks during a hands-free call, lower the volume.

Call volume

- ① In a call,  (volume up button) or  (volume down button)
 - Volume adjustment bar appears.

Call histories

Displaying call histories

- ① In the home screen,  ► [RECENTS]
 - The call history list screen is displayed.

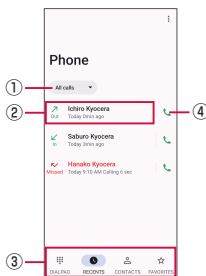

- ① **Filter**
 - Select arrived calls to display by type.
- ② **History log content**
 - Tap to display the details of a history log. Make a call, send a message, etc. to the number in a history log.

- ③ **Tabs**
 - Tap to switch between DIALPAD, RECENTS, CONTACTS, and FAVORITES.
- ④ **Dial icon**
 - Tap to make a call.

NOTE

- If using a nano SIM card and an eSIM at the same time, the SIM used is displayed in each history log.
- Tap  ► [Delete recent calls] ► Select a history log to delete ► [OK] ► [OK] to delete a call history log.

Registering a phone number in the call histories as a contact

- ① In the call history list screen, tap the number ► [Add to contacts] ► [Create new contact]
- ② Enter required items ► [SAVE]

Displaying missed calls



 is displayed in the status bar for missed calls.

- ① Slide the status bar down
- ② [Missed call]

Auto answer



Set auto answering to play a response message when you cannot answer the phone and record the caller's message.

- Maximum recordable time per 1 message →P.90

- ① In the home screen,  ►  ► [Call settings] ► [Auto answering]

Auto answering	Enable auto answering.
Answer time	Set the delay until a call is answered.
Recorded messages	Play back, delete, and protect/unprotect messages.
Response message	Set a response message.

NOTE

-  is displayed in the status bar for caller messages. Slide the status bar down ► Tap [New recorded messages] to display the recorded messages screen and check recorded messages.
- To delete a recorded message, in the recorded messages screen, tap the message to delete ► Tap  ► [Delete] ► [OK].

Call settings

Make settings for network service as well as call rejection and other settings.

- 1 In the home screen, [📞] ▶ [⋮] ▶ [Call settings]
- 2 [Call settings]

Settings for network services/roaming/Extension Line service	Make settings for network service, international roaming settings, extension line service, and sending of user information. <ul style="list-style-type: none"> • Network service →P.43 • Roaming settings →P.82 • Extension line service setting →P.43
International dial assist	International dial assist →P.81
Auto answering	Auto answering →P.42
Reject call setting	Reject call setting →P.44
Rejection message	Edit an answer message for rejecting calls, such as when unable to answer a call, and enable the message to be sent automatically.
Layout of the incoming call screen while unlocked	Set the call-arriving screen to be displayed in full screen or to be displayed with a new call notification while the screen is unlocked.
Step-up ring volume	Set whether ringtone volume gradually increases to notify you of a call from a same caller within 10 minutes.
Flashing light when incoming call	Enable the light to flash for arriving calls.
Hide Caller ID	Prevent a caller's name and image from being displayed.
Missed call notification	Set operation to display any missed call notifications again that have not been checked.
Voice memo	Voice memo →P.44
Heard effect	Adjust how the other party sounds.
Call Time	Check time for calls made domestically or abroad.

NOTE

- If using a nano SIM card and an eSIM at the same time, "Calling accounts" is displayed. [Calling accounts] ▶ Select the SIM so as to set the network service, etc.

Network service settings

- 1 In the home screen, [📞] ▶ [⋮] ▶ [Call settings] ▶ [Settings for network services/roaming/Extension Line service] ▶ [Network service]

Vicemail service	A service to answer calls with a response message and record callers' messages for you.
Call forwarding service	A service to forward calls.
Call waiting	A service to place the current call on hold and answer a new arriving call.
Caller ID notification	Enable your phone number to be displayed on the other party's phone when you make a call.
Nuisance call blocking service	Register and reject phone numbers of "nuisance calls" such as prank calls.
Caller ID display request service	Respond to calls that do not display a caller ID with guidance asking that they display their caller ID.
Call notification	Notify you of incoming call information with SMS.
English guidance	Play guidance in English for setting network services, when outside the service area, etc.
Remote operation settings	Use voicemail service, call forwarding service, etc. from a touch-tone land-line phone, pay phone, DOCOMO mobile phone, etc.
Public mode (power OFF) settings	When handset is powered off and a call arrives, play guidance that you are where mobiles must be powered off and are unable to answer, and then automatically disconnect the call.

Extension line service setting

Make settings for holding & forwarding of the extension line service as well as a prefix.

- 1 In the home screen, [📞] ▶ [⋮] ▶ [Call settings] ▶ [Settings for network services/roaming/Extension Line service]
- 2 [Extension line service setting]
 - Continue by following the instructions on the screen.

NOTE

- The extension line service is geared to corporations.

Reject call setting

- 1 In the home screen, [📞] ▶ [⋮] ▶ [Call settings] ▶ [Reject call setting]
- 2 Check the confirmation and tap [OK]

Reject unregistered call	Set to reject calls from callers not registered as contacts.
Reject call from private number	Set to reject calls from callers not sending their phone numbers.
Reject call from payphone	Set to reject calls from pay phones.
Reject unknown call	Set to reject calls from callers whose phone numbers cannot be sent.
Specified number rejection	Set to reject calls and SMS from specified numbers. <ul style="list-style-type: none">● Register a specified number: [+] ▶ Edit the phone number ▶ [ADD]

Voice memo

Playback, delete, etc. recorded voice memos and set them to "record later".

Playing back voice memos

- 1 In the home screen, [📞] ▶ [⋮] ▶ [Call settings] ▶ [Voice memo]
- 2 [Voice memo list]
 - The voice memo list screen is displayed.
- 3 Tap the voice memo to play back ▶ [▶]
 - Voice audio is played back.

NOTE

- To delete a voice memo, in the voice memo list screen, [⋮] ▶ [Delete] ▶ Select the voice memo to delete ▶ [OK] ▶ [OK].

Setting to record later

Set the record later option to ON and save conversations as voice data after ending a call.

- 1 In the home screen, [📞] ▶ [⋮] ▶ [Call settings] ▶ [Voice memo]
- 2 [Record later] ▶ Set "Use Record later" to ON

NOTE

- Tap [Recording object] ▶ [UserSetting] to set what the record later option records. Continue by following the instructions on the screen.

Contacts

Enter phone numbers, mail addresses, and other information in your contacts.

Displaying contacts

- 1 In the home screen, [☰] ▶ [docomo phonebook]
 - The contacts list screen is displayed.

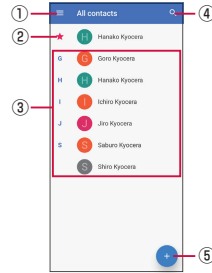

- 1 Menu
- 2 Contact registered as favorite
- 3 Image/name registered for contact
- 4 Search contacts
- 5 Register new contact

NOTE

- The first time using "docomo phonebook" for the first time (including when initializing the app) or when logging on to the cloud with the "docomo phonebook" app, a "Use of Cloud" screen is displayed and cloud use begins.

Managing contacts

Registering contacts

- 1 In the home screen, [☰] ▶ [docomo phonebook] ▶ [+]
- 2 Enter required items
 - Tap each item to enter items.
 - With some items, tap "▼" and you can change different settings.
- 3 [SAVE]

NOTE

- When registering a phone number for a landline phone, enter the area code first.

Making a call from contacts

- 1 In the home screen, [☰] ▶ [docomo phonebook]
- 2 Select the contact ▶ Tap the phone number to call

Editing contacts

- 1 In the home screen, [☰] ▶ [docomo phonebook]
- 2 Select the contact to edit ▶ [✎]
- 3 Edit items ▶ [SAVE]

Adding contacts to favorites

- 1 In the home screen, [☰] ▶ [docomo phonebook]
- 2 Select the frequently used contact ▶ [☆]

Using the menu

- 1 In the home screen, [☰] ▶ [docomo phonebook]
- 2 [☰] ▶ [Settings]

My info	Display and edit your profile.
Cloud menu	Display the cloud menu.
d ACCOUNT setting	Make d ACCOUNT settings.
International use setting	Enable use of functions that initiate communication such as cloud syncing and settings when using the docomo phonebook abroad.
Service quality improvement	Enable information on handset usage to be send to DOCOMO. ● This is turned on once you start using the cloud.
Accounts	Accounts →P.73
Default account for new contacts	Set the account where contacts are registered. Tap "Saving to" when registering to change the account.
Contacts to display	Set contacts that are displayed in the contacts list screen.
Sort by	Set order of contacts.
Name format	Set contacts to be displayed starting with their first name or last name.
Phonetic name	Set the reading displayed for contacts.
Import	Import contacts.
Export	Export contacts.
Specified number rejection	Set call rejection.

Setting labels (grouping) on contacts

- 1 In the home screen, [☰] ▶ [docomo phonebook]
- 2 [☰] ▶ [Create label]
 - If a Google Account or other account is set, select the account.
- 3 Enter the label (group) name ▶ [OK]
- 4 [👤] ▶ Tap the contact to add to the label (group)

Checking your profile and editing information

- 1 In the home screen, [☰] ▶ [docomo phonebook]
- 2 [☰] ▶ [Settings] ▶ [My info]
 - The profile screen is displayed.
- 3 [✎] ▶ Select the contact information to edit ▶ Enter items ▶ [SAVE]

Exporting / importing / sharing contacts

Import contacts from, or export them to, internal storage or a microSD card.

- Data may not be importable/exportable for some contacts.

- 1 In the home screen, [☰] ▶ [docomo phonebook]
- 2 [☰] ▶ [Settings] ▶ [Import]/[Export]
- 3 Select from where to import and how to export ▶ Select the item
 - If "Share all contacts" is selected in "Export", from the displayed notifications in the notifications panel (→P.34), tap the "docomo phonebook" notification and select the app to use for sharing.
 - Continue by following the instructions on the screen.

Mail/Web Browser

docomo mail

You can send and receive mail using a DOCOMO mail address (@docomo.ne.jp).

Exchanged mail is saved to a DOCOMO mail server, so you can migrate data when changing to a new device, or restore data if the handset is misplaced. With a d ACCOUNT, you can use the same email address across several devices such as the handset and a PC browser to send, receive, and view email.

- For details on docomo mail, refer to the NTT DOCOMO website.
https://www.docomo.ne.jp/service/docomo_mail/
(in Japanese only)

1 In the home screen, [✉]

- Continue by following the instructions on the screen.

+Message

You can send and receive text messages as well as send images, videos, stamps, etc. with mobile phone numbers serving as destinations. In addition to one-on-one messaging, chat with several people using group messaging.

You can also use the +Message app to exchange SMS (short message service) messages with people who do not use +Message.

Use an official account to exchange messages with an enterprise.

For details on +Message, in the home screen, [+Message] ▶ [MyPage] ▶ [How to use] ▶ [Refer to [use guide]], or visit the NTT DOCOMO website below.
https://www.docomo.ne.jp/service/plus_message/
(in Japanese only)

1 In the home screen, [+Message]

- In the menu at the bottom of the screen, tap "Contacts" for the contacts list screen, or "Message" for a messages list.

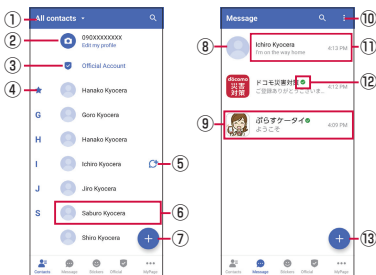

1 Switch tab

- Tap to switch between all contacts and only contacts who use +Message (with a "+Message" icon).

2 Own profile

- Own contact address appears. Tap to show or edit own profile.

3 Search for official accounts

- Tap to show official account store.

4 Favorite contacts

- Contacts registered as favorites appear at top of contacts list, below "Official Account".

5 +Message icon

- Icon to indicate the contact uses +Message. You can exchange group messages or photos, stamps, etc. with a contact with this icon.

6 Contact

- Tap to check contact details.

7 + icon

- Tap to add a contact.

8 Profile image

- Contact's profile image appears. A profile image registered by the contact will be displayed instead of a profile image you have registered.

9 Official Account

- An account held by an enterprise. A rounded square icon (□) appears.

10 Menu icon

- Show a submenu.
 - Read all: Set all unread messages as read.
 - Sort messages: Rearrange messages.

11 Message

- Tap for a message screen.

12 Checkmark icon

- Mark indicating account has passed DOCOMO screening.

13 + icon

- Create a new message or new group message.

Sending messages

1 In the home screen, [+Message]

2 In the menu at the bottom of the screen, [Message] ▶ [+] ▶ [New message]/[New group message]

- Group message allows you to exchange messages with several people who use +Message service (contact with +Message mark).

3 Select the destination

- To send to a destination not saved in contacts, tap "Enter name and phone number", and enter the phone number directly.
- For a group message, select the destinations, and tap "OK".

4 Tap the message entry field ▶ Enter text ▶ [Send]

- If the destination uses +Message, you can send photos, videos, and stamps.

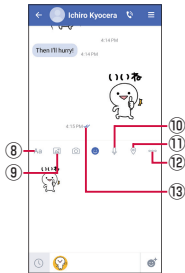
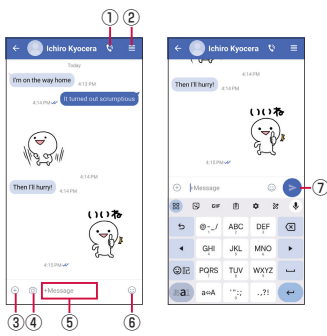

- ①
 - The phone app activates and dials.
- ②
 - Show a submenu.
 - Register contacts, or change notification settings.
- ③
 - Show the share tray to send photos, stamps, location, etc.
 - After showing the share tray, also use image-send and audio-record functions.
- ④
 - Tap to activate camera. Touch and hold to take and then immediately send a photo.
- ⑤ **Message entry field**
 - Enter a message.
- ⑥
 - Change to stamp selection screen.
- ⑦
 - Send an entered message.
- ⑧ **Aa**
 - Change to a text entry screen.
- ⑨
 - Change to an image selection screen.
- ⑩
 - Change to an audio recording screen.
- ⑪
 - Change to a map screen.
- ⑫
 - Select Contacts, Sketch, or Gallery.
- ⑬ **Sendout progress**
 - Display the message's sendout progress.
 - ✓: Recipient has viewed message
 - Both senders can check if each other's messages have been read only if they

- both have enabled the "Use message read function" setting.
- ✓: Recipient has received message on their device
- No icon: Message has been sent to server
- ✗: Message failed

Important regarding SMS (short message service)

- Service is available also with people who use overseas carriers. For details on countries/regions and carriers where service is available, see the NTT DOCOMO website.
- If destinations are devices owned by those who use network of overseas network operators, enter "+", the country code, and the recipient's mobile phone number. If the phone number begins with "0", enter the number omitting the first "0". Alternatively, enter "010", the country code, and the phone number.
- SMS cannot be sent to a destination with a "#" or "*".
- SMS cannot be sent to a destination with 184/186 added.

Important regarding +Message

- To use the +Message app with overseas roaming, in the +Message app, set the setting for using +Message during overseas roaming to "ON" (setting is set to "OFF" at initial setting). Also set data roaming to "ON" on the handset.
- Even if you have used +Message before changing to a new device or changing carriers with MNP, you must activate the +Message app and agree to +Message terms of service before receiving messages.

Reading messages

Exchanged messages are shown in threads grouped for each destination/sender.

- ① In the home screen, [+Message]
- ② In the menu at the bottom of the screen, [Message] ▶ Select the thread with message to read
 - For details on functions used when replying to messages. →P.46

Forwarding messages

- ① In the home screen, [+Message]
- ② In the menu at the bottom of the screen, [Message] ▶ Select the thread
- ③ Touch and hold the message to forward ▶ [i] ▶ [Forward]
- ④ Select the destination ▶ Enter the message ▶ [▶]

Deleting messages

- 1 In the home screen, [+Message]
- 2 In the menu at the bottom of the screen, [Message] ▶ Select the thread
- 3 Touch and hold the message to delete ▶ [ⓘ] ▶ [Delete] ▶ [Delete]
 - Only the message on the handset is deleted. The message on the other person's device is not deleted. Deleted messages cannot be restored.
 - Touch and hold several messages to select the messages and delete them together. If not shown, tap [削除] ▶ [Delete].

Deleting threads

- 1 In the home screen, [+Message]
- 2 In the menu at the bottom of the screen, [Message] ▶ Touch and hold the thread to delete
- 3 [削除] ▶ [Delete]
 - After deleting the thread or a group message, you are no longer in the group.

Changing +Message settings

- 1 In the home screen, [+Message]
- 2 In the menu at the bottom of the screen, [MyPage] ▶ [Settings]

Message	Make message settings, back up data or copy data back, etc.
Official Account	Set a notification ringtone for official accounts.
Photos and videos	Make settings for sent/received attachments such as photos and videos.
Screen display	Set a theme color or background for the message screen.
Notification	Make notification settings.
Privacy	Set a passcode and blocking.
Others	Set user information transfer, initialize +Message service, etc.

Using the Official Account Function

- 1 In the home screen, [+Message]
- 2 In the menu at the bottom of the screen, [Official Account]
- 3 In the "Official Account" screen, tap the account to use
- 4 Tap the [I have read and accepted the Terms and conditions and will use this Official Account] checkbox

5 [Start]

Gmail

Use Google's e-mail service and e-mail by general providers.

- If you have not set a Google account or e-mail account, follow the instructions on the screen.

Displaying Gmail

- 1 In the home screen, [Google] ▶ [Gmail]
 - A list of message threads is displayed.

NOTE

- For details on Gmail, [☰] ▶ Tap [Help & feedback] and check the Gmail Help.

Early Warning "Area Mail"

This service enables you to receive Earthquake Early Warnings and Tsunami Warnings from the Meteorological Agency, and Disaster and Evacuation Information from national or local authorities, regardless of busy network conditions.

- Area Mail is a free service that does not require a subscription.
- Area Mail cannot be received in these situations.
 - While powered off
 - During international roaming
 - While in airplane mode
 - During a software update
 - While the entry screen for the PIN code is displayed
 - During voice calls (except for voice calls with VoLTE)

Receiving early warning "Area Mail"

After Area Mail is received, a notification is displayed, and the handset emits an alert buzzer sound or ringtone and vibrates.

- The buzzer sound or ringtone cannot be changed.

- 1 Area Mail is received automatically
- 2 After Area Mail is received, the handset emits an alert buzzer sound or ringtone
 - An icon is displayed in the status bar.
- 3 The content of the Area Mail is displayed

Checking received Area Mail later

- 1 In the home screen, [☰] ▶ [Tools] ▶ [Disaster kit]
- 2 [Early Warning "Area Mail"] ▶ [Area Mail]
- 3 In the Area Mail list, select an Area Mail

Deleting Area Mail

- Deleted Area Mail cannot be restored.

- 1 In the home screen, [⌘] ▶ [Tools] ▶ [Disaster kit]
- 2 [Early Warning "Area Mail"] ▶ [Area Mail]
- 3 In the Area Mail list, touch and hold an Area Mail ▶ [delete] ▶ [delete]

Web browser

You can use a web browser to view Internet websites via packet communication and Wi-Fi in the same way as a computer.

Displaying websites

- 1 In the home screen, [🌐]
 - The website is displayed.

Basic operations when a website is displayed

- Use the following operations to view websites (operations may be unavailable in some websites).
 - Tap: select or okay links and buttons.
 - Slide/flick: scroll pages.
 - Zoom in/out: enlarge/shrink pages.
 - Slide the screen left/right to go back to the previous page.
- To copy text in a website, touch and hold the text ▶ Drag "↔"/"↔" to select the text range ▶ [Copy] ▶ Touch and hold the entry field where to paste the text ▶ Tap [Paste].

Entering a URL or search words to display a website

- 1 Tap URL display field at the top of a displayed website
- 2 Enter a website address or search words ▶ [→]
 - When searched candidates including the entered text are displayed listed below the URL display field, you can tap a candidate to display a webpage.
 - Tap "⬆" to go back to the page set as your homepage.

Adding new tabs

Open several tabs to view websites.

- 1 In a displayed website, [⋮] ▶ [New tab]
 - The website is displayed.

Switching tabs

- 1 In a displayed website, [🔍]
 - A number icon is the number of opened tabs. Display differs depending on current usage.
- 2 Select the tab to display

Closing tabs

- 1 In a displayed website, [🔍]
 - A number icon is the number of opened tabs. Display differs depending on current usage.
- 2 Tap the "X" at the upper right of the tab to close.
 - Alternatively, slide the tab to close to the left or right to close.

Opening Incognito tabs

Display websites without leaving a viewing history or search history.

- 1 In a displayed website, [⋮] ▶ [New Incognito tab]
- 2 Display the website
 - To close an Incognito tab, while the website is displayed, [🔍] ▶ [X].
 - A number icon is the number of opened tabs. Display differs depending on current usage.

Changing web browser settings

- 1 In the home screen, [🌐]
- 2 [⋮] ▶ [Settings]

Turn on sync	Enable synchronization.
Google services	Set Google services.
Search engine	Set the search engine.
Password Manager	Enable saving of passwords entered in websites.
Payment methods	Enable auto-entry of payment method, and set credit card information used for auto-entry.
Addresses and more	Enable auto-entry of residential address, and save information used for auto-entry such as address, name, phone number, and email address.
Privacy and security	Set access to payment method and page preload, and delete viewing history.
Safety check	Check whether you have been protected from threats such as data breaches and unsafe websites.
Notifications	Set the Chrome notification method.
Theme	Set the Chrome theme.
Homepage	Set the page displayed when tapping "⬆".
Accessibility	Set the size of text, zoom, etc.
Site settings	Make cookie, JavaScript, and other website settings.
Languages	Display website text in the set language. <ul style="list-style-type: none">• Some websites may not be displayed in the set language.
Downloads	Set the location to save to, etc. when downloading

About Chrome	Check information such as the Chrome version.
--------------	---

Using bookmarks/history

Use registered bookmarks and history to display websites.

Registering bookmarks

Register a displayed website as a bookmark.

- 1 In the home screen, [🌐]
- 2 Display the website to register as a bookmarks
- 3 [⋮] ▶ [☆]

Displaying websites from bookmarks

- 1 In the home screen, [🌐]
- 2 [⋮] ▶ [Bookmarks]
 - The bookmarks screen is displayed.
- 3 Select the website to display

Displaying websites from history

- 1 In the home screen, [🌐]
- 2 [⋮] ▶ [History]
 - A history screen is displayed.
- 3 Select the website to display

Using the bookmarks/history screen menus

In the bookmarks/history screen, you can edit, delete, etc. bookmarks and history. Follow the instructions on the screen.

Camera/Gallery

Camera

Before using the camera

Take still images and videos using the out-camera or in-camera on the handset.

All taken still images and videos are saved to microSD card or the internal storage.

- Fingerprints/smudges on the lens will prevent clear still images/videos from being taken. Before taking still image/videos, wipe the lens with a soft cloth beforehand.
- Avoid fingers, hair, straps, etc. from covering the lens when taking still images/videos.
- Be careful with handheld shake. To prevent this from causing blurry images, hold the handset firmly so it does not move, or use the self-timer function. Note that blurry images tend to occur more easily especially in low-lit conditions such as indoors. Also note that blurry images can also occur easily if the subject moves.
- Check that the subject appears completely in the display, then tap the shutter. The camera moving as the shutter is tapped can cause blurry images.
- When recording video, be careful not to cover the microphone with fingers, etc. Depending on how audible voice is and on the surroundings during recording, the audio quality of the microphone may be affected.
- The camera may not focus on the following kind of subject.
 - Low-contrast subject such as a solid-color wall
 - Strongly back-lit subject
 - Highly reflective subject such as a shiny object
 - Subject with a repeating horizontal pattern such as blinds
 - Several subjects of differing distances from the camera
 - Subject in a dark location
 - Fast-moving subject
- Do not shine the camera light close to your eyes. Do not look at the camera light directly while in use. Do not shine the camera light at other people's eyes. May be harmful such as by affecting eyesight.
- Even while in Manner mode, the focus lock sound for still images, the shutter sound, and video recording tones still sound.
- Placing the handset on an unstable surface to take a self-timer shot may allow it to fall if the handset vibrates for an arriving call.
- If copying, editing, etc. images or audio captured using the handset, not only should you refrain from any use that infringes on copyrights, you should also refrain from any use that infringes on any right of portrait, such as using or changing anyone's portrait without their permission. Note that photography, audio recording, etc. at demonstrations, performances, or exhibitions may be prohibited even if only for personal use.
- Inappropriate behavior using the handset camera and creating a public nuisance may be punishable by

law/anti-nuisance ordinance.

- Caution: uploading photos to the Internet with appended location information may allow their location to be known by third persons.
- The camera cannot be used in extremely warm conditions. The handset display may decrease in brightness in response to a rising temperature while being used.

Viewfinder layout

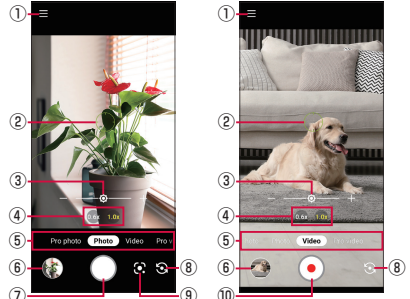

Photo (still image) viewfinder

Video viewfinder

- ① **Menu**
 - The camera settings screen is displayed (→P.52).
- ② **Focus frame**
 - Tap where to focus on subject and focus frame appears where tapped.
- ③ **Brightness adjust bar**
 - Tap the screen to keep it displayed for a certain time. Drag the adjust bar left/right to adjust screen brightness.
- ④ **Zoom magnification**
 - Tap the magnification to adjust the zoom. Tap the selected magnification (yellow text) again to display the adjust bar. Drag the adjust bar left/right to fine-adjust the magnification. Alternatively, pinch out/in in the viewfinder to adjust the zoom.
- ⑤ **Shooting mode**
 - Tap or slide to switch shooting modes.
- ⑥ **Preceding taken/recorded data**
 - Display a thumbnail of the preceding taken/recorded data. Tap to check the data.
- ⑦ **Take photo (shutter)**
- ⑧ **Switch in-/out-camera**
- ⑨ **Google Lens**
 - Work with text the camera is held over, view information on the surroundings, or check names and varieties of plants and animals.
- ⑩ **Record/stop**
 - Start/stop video capture.

NOTE

- If there is no operation on the viewfinder for about 2 minutes, the camera exits.

Taking still images

- ① In the home screen, [Camera]

2 [Photo]

- Alternatively, slide the screen left/right to switch.

3 Tap the screen

- The camera focuses where the screen is tapped.
- Touch and hold the viewfinder to lock focus.

4 [○]

- The taken data is saved automatically.
- Touch and hold "○" to shoot continuously.

NOTE

- The handset is equipped with continuous auto-focus, however, focusing may take time with some subjects.

Taking video

1 In the home screen, [Camera]

2 [Video]

- Alternatively, slide the screen left/right to switch.

3 [●]

- Recording starts.
- Tap "○" while recording to take a still image.

4 [○]

- Recording stops. The recorded data is saved automatically.

NOTE

- When recording, be careful not to cover the mouthpiece/microphone with fingers, etc.

Pro photo/Pro video screen layout

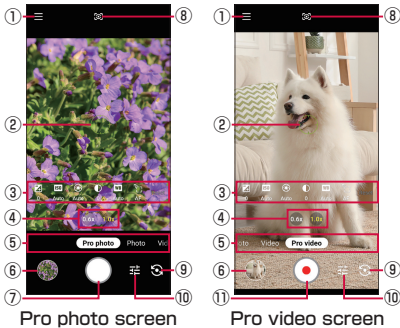

1 Menu

- The camera settings screen is displayed (→P.52).

2 Focus frame

- Tap where to focus on subject and focus frame appears where tapped.

3 Setting options

- Tap options to change settings.



: Adjust the focus.

Reset: Return settings to their values at time of purchase.

4 Zoom magnification

- Tap the magnification to adjust the zoom. Tap the selected magnification (yellow text) again to display the adjust bar. Drag the adjust bar left/right to fine-adjust the magnification. Alternatively, pinch out/in in the viewfinder to adjust the zoom.

5 Shooting mode

- Tap or slide to switch shooting modes.

6 Preceding taken/recorded data

- Display a thumbnail of the preceding taken/recorded data. Tap to check the data.

7 Take photo (shutter)

8 Metering mode

- Set from "Center" / "Average" / "Spot".

9 Switch in-/out-camera

10 Show/hide setting options

11 Record/stop

- Start/stop video capture.

NOTE

- If there is no operation on the viewfinder for about 2 minutes, the camera exits.

Capturing with Pro photo/Pro video

1 In the home screen, [Camera]

2 [Pro photo]/[Pro video]

- Alternatively, slide the screen left/right to switch.

3 Set each item

4 [○]/[●]

- The taken data is saved automatically.
- For "Pro video", tap "■" after capturing a scene to stop recording.

Camera settings

1 In the home screen, [Camera]

2 [≡]

Aspect ratio	Select the aspect ratio.
Resolution	Select the video resolution.
Flash	Set how the camera light flashes.
Self timer	Set the self-timer for taking a still image. The still image is taken once the set number of seconds elapse. <ul style="list-style-type: none"> • While counting down, the camera beeps and the camera light flashes.
More settings	Detailed camera settings →P.53

* Shown items and their arrangement may differ depending on current settings.



NOTE

- When taking a still image, the capturable size differs between the out-camera and the in-camera. Capturable sizes are the following.
 - Out-camera: approx. 16 million pixels, CMOS (switchable to wide-angle shooting)
 - In-camera: approx. 8 million pixels, CMOS

Detailed camera settings

1 In the home screen, [Camera]

2  ▶ [More settings]

Auto HDR	Combine several images of differing exposure into a single image to capture images while preventing whited-out and blacked-out portions.
Image stabilization	Switch handheld shake correction settings.
Recording file format	Select the recording format for videos.
Recording Type	Select the recording method for videos.
Mute audio	Capture video without audio.
Wind noise reduction	Decrease wind noise while capturing videos.
Disabling notifications	You can prevent sound and vibration from notifications from also being captured along with video content.
Continuous shooting	Set the camera to shoot continuously when the shutter is long-pressed when taking still images.
Storage	Set storage.
Add location information	Appends location information to all still images/videos taken after being set.
Preserve last mode	Camera activates in the previously used mode.
Volume key	Set functions assigned to the  (volume up button)/  (volume down button).
Quick social media	Slide upward in the viewfinder to link the latest capture data with the set app.
Level	Enable a level to be displayed.
Grid	Enable a grid to be displayed.
Scan QR code	Enable the camera to recognize QR codes (barcodes) automatically in the photo capture screen and scan them.
Lens distortion	Enable distortion during capture to be corrected.
Choose theme	Select a theme from the camera app from "Light" / "Dark" / "System default".
Camera function guide	Check camera functions.
Reset settings	Return camera settings to their values at time of purchase.

* Shown items and their arrangement may differ depending on current settings.

Barcode scanner



Continuously scan barcodes and QR codes, or scan several at once. You can also activate linked apps automatically by scanning data.

Before using the barcode scanner

- Although operation has been verified under conditions of general usage, a barcode may not be scanned correctly (misscanned, unrecognizable) depending on such conditions of use as in dark surroundings and the type, size, etc. of the code. A code may also be incorrectly scanned as a result of soiling, fading, a curving surface, reflection, etc. Be sure to check before using the scanner.
- The scanner uses the camera, and therefore fingerprints/smudges on the lens will prevent clear images from being obtained, resulting in affected performance. Before using the scanner, wipe the lens with a soft cloth beforehand.
- If a higher-grade scan function is required, we have a separately available option (recommended app). Inquire at Customer Support (0120-500-349).
 - Usage fees are required separately for use of option.

Scanning barcodes

1 In the home screen,  ▶ [Barcode Scanner]

- The scan viewfinder is displayed.
- If a settings screen appears, follow the instructions on the screen.
- You can also press  (direct key Left)/ (direct key Right) to activate the barcode scanner by default settings.

2 Point the handset out-camera on toward the barcode/QR code to scan

- When "Automatic scan" is ON, scanning finishes and the linked app activates.
 - Set the app to link beforehand with "App linkage".
- If "Automatic scan" is OFF, set "Scan button" to ON, and tap .

NOTE



- To set "Automatic scan" to ON, in the scan viewfinder,  ▶ Set "Automatic scan" to ON.

Barcode scanner settings

1 In the home screen,  ▶ [Barcode Scanner]

2 

Multi scan	Switch between single scanning and multiple scanning.
------------	---

Continuous scan	Enable the camera to continuously scan in several instances of data.
Automatic scan	Enable the camera to automatically scan in data simply by pointing the handset out-camera.
Barcode types	Set the format of data to scan in.
App linkage	Set linked apps.
Sound alert volume	Set the volume of the notification ringtone when scanning in data.
Vibration alert	Enable vibration when scanning in data.
Aimer	Enable lines to be displayed around the scan area and at the middle of the screen.
Scan button	Enable  to be displayed in the scan viewfinder.
Scan QR code	Enable apps that match the scanned content to activate when scanning QR codes.
Automatic linkage	Enable the app set with "App linkage" to activate when scanning in data.
Duplicate scan	Enable same data to be scanned in.
Duplicate confirmation	Enable confirmation to be displayed when scanning in same data.
Save scan data	Enable scanned in data to be saved.
Save data format	Set the format for saving data.
Data file prefix	Append set text to the beginning of the file name of saved data.
Data file suffix	Append set text to the end of the file name of saved data.
Data prefix	Append set text to the beginning of scanned-in data.
Data suffix	Append set text to the end of scanned-in data.
Add tab key	Append a  key to the end of scanned-in data.
Add enter key	Append an enter key to the end of scanned-in data.
Function guide	Check barcode scanner functions.
Reset settings	Return barcode scanner settings to their values at time of purchase.

* Shown items and their arrangement may differ depending on current settings.

Photos

Use to display and play back from a listing of images/videos in the internal storage or on microSD card. You can manage them as an album.

Displaying photos and videos

1 In the home screen, [Photos]

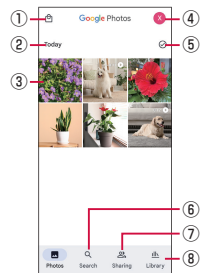

1 Photo print

- Order photo printing.

2 When data created

3 Saved data

4 Account menu

- Manage Google Accounts, make "Photos" app settings, and check help files, privacy policy, and terms of use.

5 Select all

6 Search photos

7 Share

- Set partner accounts for sharing, and check shared photos.

8 Library

- View album and archived data.

2 Select data

- Data is displayed.
- Tap displayed data to display menu items such as share and delete.

NOTE

- Some data displayed in the "Photos" app may not be played back.
- For details on the "Photos" app, tap the account icon at the upper right of the Photos screen ▶ [Help & feedback] ▶ Tap [Help] and check the help.

Deleting photos and movies

1 In the home screen, [Photos]

2 Touch and hold the data to delete

- Check that a checkmark appears at the upper left.
- To also delete other data, tap the data to checkmark it.

3 [Delete] ▶ [Move to trash]

- If confirmation appears, follow the instructions on the screen.

Apps

dmenu

A portal site allowing access to a wide range of contents and services from DOCOMO.

1 In the home screen, [dメニュー]

- Web browser activates and "dメニュー" is displayed.
- Before using the site, check "サイトご利用にあたって".
<https://smt.docomo.ne.jp/portal/src/terms.html>
(in Japanese only)

Play Store

Use **Google Play** to download and install useful apps and enjoyable games to the handset.

- You must set a Google account to use Google Play(→P.73).
- For details on purchasing, returning, and requesting refunds for paid apps, tap the account icon at the upper right of the **Google Play** screen, then in "Help & feedback", check the Help in **Google Play**.
- Agreeing to installing an app is agreeing to responsibility for use of the app. In particular, be careful with apps that access many functions or large amounts of data.
- When installing apps, be sure to check that they are safe, and then run them assuming all responsibility. There is a possibility of virus infection, data corruption, etc.
- DOCOMO is not responsible for any operational malfunction or disadvantage resulting for user or third parties from use of third-party apps including those provided by **Google LLC** that you have installed.
- For details on third-party apps including those provided by **Google LLC** that you have installed from **Play Store**, inquire with each provider.

Installing apps

1 In the home screen, [Play Store]

- The **Google Play** screen is displayed.

2 Search apps ▶ Select the app to install

- Check the content and follow the instructions on the screen.

NOTE

- Some apps may initiate packet communication automatically. Note that continuing to use the handset may incur high packet communication fees.
- Some apps update automatically.

Uninstalling apps

1 In the home screen, [Play Store]

- The **Google Play** screen is displayed.

2 Tap the account icon at the upper right of the **Google Play** screen

- The **Google Account** menu is displayed.

3 [Manage apps & device] ▶ [Manage]

4 Tap the app to uninstall ▶ [Uninstall] ▶ [Uninstall]

- To uninstall a paid app, follow the instructions on the screen. For details, see the Help for **Google Play**.

Osaifu-Keitai

Osaifu-Keitai is a function for using "Osaifu-Keitai-compatible services" which enable you to make payment, use the handset as a coupon, etc. by simply holding it over scanning devices at stores and other locations, without activating a **Osaifu-Keitai-compatible app**.

You can save electronic money, points, etc. on the **IC card**, check the balance and the remaining points, etc. You can also lock **Osaifu-Keitai** functions in case of theft or loss.

For details on **Osaifu-Keitai**, refer to the **NTT DOCOMO website**.

- To use **Osaifu-Keitai** compatible services, it is necessary to make settings through sites or apps.
 - The handset malfunctions may cause data on the **IC card*** to be lost or changed (Note that as a rule, you will be asked to delete data when leaving your handset for repairs etc., since we cannot keep your handset with such data still remaining in it). For the service such as a reissue, restoration, temporary keeping or transference of the data, contact a provider of the **Osaifu-Keitai** compatible service you use. Be sure to use the **Osaifu-Keitai** compatible service including a backup service for important data.
 - DOCOMO shall not be liable for any loss or change of data on the **IC card** or other damages related to **Osaifu-Keitai** compatible services caused by any reason such as malfunctions and model changes.
 - When the handset is stolen or lost, immediately contact a provider of the **Osaifu-Keitai** compatible service you use for handling methods.
- * The data saved on the built-in **IC card** of the **Osaifu-Keitai-compatible handset**

Using "Osaifu-Keitai-compatible services"

To use Osaifu-Keitai-compatible services, make the settings of the Osaifu-Keitai-compatible app.

- 1 In the home screen, [⌘] ▶ [Tools] ▶ [Osaifu-Keitai]
 - If initial settings are not completed, the initial settings screen appears. Follow the instructions on the screen.
- 2 Select a service
- 3 Make settings for the service
 - Make settings from the app or website for the service.
- 4 Hold the  mark of the handset over the scanning device



NOTE

- Although you can use Osaifu-Keitai with the handset powered off, being powered off for a prolonged period or having a low battery may prevent you from using it.
- Regardless of the handset's "Battery Saver" (→P.66) or "Data Saver" (→P.65) settings, Osaifu-Keitai-compatible apps initiate communication as necessary in the background to benefit from Osaifu-Keitai-compatible services, and packet communication charges may be incurred.
- After powering on or restarting the handset, or after updating software, unlock the screen before holding the handset up to a scanning device to use Osaifu-Keitai-compatible services.

Precautions about holding over the other device

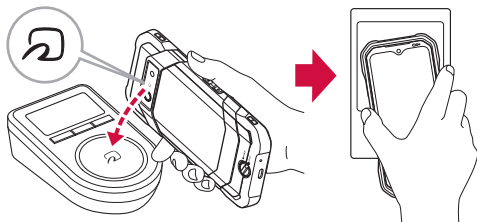
Pay attention to the following points when holding the mark over the other device such as a scanning device or device into which an NFC module is built.



- Do not let the handset strongly clashed with the other device but slowly bring the handset close to the other device when holding the  mark over it.
- Hold the  mark over the center of the other device and in parallel with it. If the other device does not recognize the built-in IC card even when you do so, slightly move the handset away from the other device or move the handset around.
- The other device may not recognize the built-in IC card if there are metallic objects between the  mark and the other device. Remove the handset

from its cover or case if the other device does not recognize the built-in IC card, since equipping the handset with it may influence the communication performance.

Setting the NFC/Osaifu-Keitai function to ON

- 1 In the home screen, [⌘] ▶ [Settings] ▶ [Connected devices] ▶ [Connection preferences]
- 2 [NFC/Osaifu-Keitai] ▶ Set "NFC/Osaifu-Keitai" to ON
 - The NFC/Osaifu-Keitai function is set to ON, and all Osaifu-Keitai-compatible services are available.

Locking the NFC/Osaifu-Keitai function

Set the NFC/Osaifu-Keitai function to OFF while the screen is locked.

- 1 In the home screen, [⌘] ▶ [Settings] ▶ [Connected devices] ▶ [Connection preferences]
- 2 [NFC/Osaifu-Keitai] ▶ Set "NFC/Osaifu-Keitai lock ON/OFF" to ON

Using contactless payment

- 1 In the home screen, [⌘] ▶ [Settings] ▶ [Connected devices] ▶ [Connection preferences]
- 2 [NFC/Osaifu-Keitai] ▶ [Contactless payments]
- 3 [Default payment app] ▶ Select the app ▶ [←]
- 4 [Use default payment app] ▶ [Always] / [Except when another payment app is open]
- 5 Hold the  mark of the handset over a scanning device that has a contactless payment mark

NOTE

- Set the NFC/Osaifu-Keitai function to ON beforehand (→P.56).

iD appli

"iD" is electronic money provided by DOCOMO. You can pay by holding an Osaifu-Keitai in which "iD" is set over scanning devices at stores.

- For using iD with Osaifu-Keitai, setting of iD appli is required. For details on having one issued, fees, etc., inquire with each credit card company.

- For information on iD, refer to the iD website (<https://id-credit.com/>) (in Japanese only).

Radio

Using radiko+FM

Listen to radio shows being broadcast in your area over the Internet.

You can also receive FM radio by connecting commercial earphones to the handset earphone mic terminal.

- 1 In the home screen, [田] ▶ [radiko+FM]
 - A listing of Internet radio stations is displayed.
- 2 Select a station

Receiving FM radio

To receive FM radio, connect commercial earphones to the handset earphone mic terminal.

- 1 Station list screen ▶ [田] ▶ [FMチューナー] (FM tuner)
- 2 [田] ▶ [放送局を選択してください] ▶ Select the station ▶ Select 本局 (main station) or 中継局 (relay station) ▶ [閉じる] (Close)
- 3 [▶]

NOTE

- For details on Internet radio, tap [田] ▶ [ヘルプ] (Help) and check information.
- Commercially available earphones act as the antenna for receiving FM radio.
- FM radio reception may be poor indoors or in a vehicle. Reception is better when as near a window as possible.

Location services

Use of apps compatible with the GPS function allow you to display your current location, search for routes to destinations, etc.

GPS function

- The handset contains a GPS receiver that can use satellite signals to determine current location. Packet communication charges may be incurred for using the GPS function.
- Exercise plenty of caution when using the GPS system. DOCOMO is not responsible for damages from system problems, etc.
- DOCOMO is not responsible for any (pure economic loss (damages, etc.) resulting from lost opportunities such as checking location (communication) results due to malfunction, misoperation, external causes such as power stoppages (including power outages), etc. of the handset.
- The handset cannot be used as a navigation device

for aircraft, vehicles, persons, etc. As a result, DOCOMO is not responsible for any damages that may occur from navigating using location information.

- It cannot be used as high-accuracy locating GPS. As a result, DOCOMO is not responsible for any damages that may occur from discrepancies in location.
- GPS is a service administered by the US Department of Defense. Therefore, the condition of GPS radio waves may be controlled (accuracy degradation, radio wave stop, etc.) for US national security reasons.
- Wireless communication products (mobile phones, data search devices, etc.) may hinder satellite signals, and signal reception is sometimes unstable.
- Depending on the legal requirements in each country/region, indications on maps based on obtained location information (longitude and latitude) may not be accurate.

Locations with poor reception

Note that GPS uses radio waves from artificial satellites, and therefore the following conditions may prevent radio waves from being received or prevent the reception of radio waves from being satisfactory.

- In or under buildings
- Inside a basement or tunnel, underground, or underwater
- Inside bags or boxes
- In a high-density area with buildings or residences
- In or under a dense forest
- Near high-tension lines
- Inside cars, trains, etc.
- In bad weather with heavy rain/snow, etc.
- When people or objects are blocking the handset

Setting the GPS function/location service to ON

- 1 In the home screen, [田] ▶ [Settings] ▶ [Location] ▶ Set "Use location" to ON ▶ [OK]

Using Google Maps

Use Google Maps to display your current location and to search for locations, search routes, etc.

- To use Google Maps, check that the handset is connected to the network (→P.34).
 - Google Maps does not necessarily cover all countries and regions.
- 1 In the home screen, [Google] ▶ [Maps]
 - For details on Google Maps, in the map screen, tap the account icon at the upper right of the map screen ▶ [Help & feedback] ▶ Tap "Help" and check the help.

Clock

Use alarms, world clocks, a timer, stopwatch, etc.

Setting alarms

Be prompted with an alarm or handset vibration at a specified time.

- 1 In the home screen, [Google] ▶ [Clock] ▶ [Alarm]
- 2 [⋮]
- 3 Set the time ▶ [OK]
 - To edit a set alarm, tap the alarm to edit, and select the items to change.
- 4 Set details

Add a label	Set a label name.
Day	Set days to repeat the alarm.
Set alarm	Set the date of the alarm.
Alarm sound	Set the alarm sound.
Vibrate	Enable vibration at same time as alarm sound.
Google Assistant Routine	Enable usage of Google Assistant Routine.
Delete	Delete an alarm.

NOTE

- When the time for an alarm arrives, the alarm sounds and the handset vibrates, and the label name is displayed.
- If an alarm starts while in a call, an alert tone sounds from the earpiece/speaker.
- An alarm does not sound if the handset is not powered on.
- To turn an alarm off, tap " ".

Stopping alarms

- 1 While an alarm is sounding, drag "  " to "Stop"
 - The alarm stops.

NOTE

- Drag "  " to "Snooze" to let the alarm sound again after the set time elapses (snooze the alarm).
- When the screen is on (except for the lock screen), tap "Snooze"/"Stop".

Deleting alarms

- 1 In the home screen, [Google] ▶ [Clock] ▶ [Alarm]
- 2 [✓] for the alarm to delete ▶ [Delete]

Using world clocks

You can register several cities and check dates and times.

- 1 Home screen ▶ [Google] ▶ [Clock] ▶ [Clock] ▶ [⋮]
- 2 Enter the name of the city ▶ Select the city from the list

NOTE





- Slide an added city left/right to delete the city.

Using the timer

You can set the timer to sound at a set time.

- 1 In the home screen, [Google] ▶ [Clock] ▶ [Timer]
 - The timer screen is displayed.
- 2 Enter the time ▶ [⋮]
 - Countdown starts. When the countdown finishes, the timer sounds. Tap "  " to stop the timer sound.





NOTE

- Tap "+1:00" to add 1 minute.
- Tap "  " to pause countdown, and "  " to restart. Tap "  " to reset the countdown.
- Tap "  " to delete the timer.

Using the stopwatch

- 1 In the home screen, [Google] ▶ [Clock] ▶ [Stopwatch]
 - The stopwatch screen is displayed.
- 2 [⋮]
 - Timing starts.

NOTE

- Tap "  " to pause timing, and "  " to restart. Tap "  " to reset timing.
- Tap "  " to time laps.



Using Bedtime

Set handset operation for when sleeping or waking in the morning, to play relaxing sound before sleep, etc. to support comfortable sleep.

- 1 [Google] ▶ [Clock] ▶ [Bedtime]
 - Continue by following the instructions on the screen.

Setting the clock

- 1 In the home screen, [Google] ▶ [Clock] ▶ [Alarm] / [Clock] / [Timer] / [Stopwatch] / [Bedtime]
- 2 [⋮] ▶ [Settings]

Style	Select a clock style from "Digital"/"Analog".
Display time with seconds	Enable seconds to be displayed.
Automatic home clock	Enable the time difference to be shown between the time set at your home and your current location in a different time zone.
Home time zone	Set the time at your home.
Change date & time	Date and time →P.74
Silence after	Set the time until the alarm sound stops.
Snooze length	Set the time until a "snooze" alarm sounds again.
Alarm volume	Set the alarm volume.
Gradually increase volume	Enable alarm volume to increase gradually.
Volume buttons	Set functions assigned to the  (volume up button)/  (volume down button).
Start week on	Set the starting day of the week.
Timer sound	Set the timer sound.
Gradually increase volume	Enable timer volume to increase gradually.
Timer vibrate	Enable vibration when timer sounds.
Style	Select a clock style for the screen saver from "Digital"/"Analog".
Night mode	Set the screen brightness when a screen saver is set.

Schedule

Using a schedule

You can show the calendar and register a schedule.

- In the home screen,  ▶ **[Tools]** ▶ **[Schedule]**
 - A schedule screen is displayed.
- Check the schedule

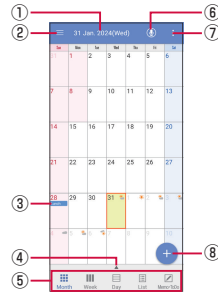

- Selected date, name of holiday**
 - Display settings menu, help, etc.
- Registered schedule event**
- Separator**
 - Tap to display scheduled events for the selected date. Uncompleted ToDo tasks are also displayed for schedule events or memos with ToDo tasks set.
- Switch display**
 - Switch schedule display, such as month display and week display.
- Voice input**
 - Use my daiz with voice entry.
- ⋮**
 - Move dates, synchronize with the cloud, etc.
- Create an event**

Schedule settings

- Schedule screen ▶ 
- [Settings]**

Alarm	Make alarm settings.
Initial screen	Set how the schedule is displayed when activated.
Starting day	Set the starting day for the calendar.
Label display	Enable labels registered for schedule events to be displayed in month display and week display.
Title setting	When creating a schedule event, set titles to be entered automatically to match selected label icons.

"Birthdays display" setting	Set birthdays registered in contacts to be displayed in the schedule.
Birthday color setting	Set the display color for birthdays.
"Weekly weather display" setting	Set the week's weather forecast to be displayed in the schedule.
Cloud setting	Enable cloud usage.
Overseas usage setting	Restrict functions that operate together with communication when the handset detects that it is abroad.
National holiday data update	Reflect updated holiday data in the schedule.
Delete all data in app	Delete all "Schedule" app/"Memo" app data. Tap "DELETE", then check displayed content before deleting it.

Creating schedule entries

- 1 Schedule screen ▶ [+]
- 2 Enter required items ▶ [Save]

Deleting schedule entries

- 1 Schedule screen ▶ Select the day
- 2 Touch and hold the schedule entry to delete
- 3 [Delete one] ▶ [DELETE]

Memo

App for creating/managing memos.

Using memos

- 1 In the home screen, [≡] ▶ [Tools] ▶ [Memo]
- 2 [+]
- 3 Enter the memo ▶ [Save]

Calculator

Using the calculator

Use handset calculator.

- 1 In the home screen, [Google] ▶ [Calculator]
 - The calculator screen is displayed.
 - "AC": erase a calculation result.
 - "X": erase the last-entered number/symbol.

docomo Data Copy

"docomo Data Copy" allows you to copy data saved on the handset to another device or back up/copy back data.

Use this app to migrate data when changing to a new device, or to regularly back up important data.

- Depending on the device model, operating system, and type of files, you may not be able to copy, back up, or copy back data properly.
- Contact entries that can be copied or backed up are those registered in a docomo or handset account.
- A low battery level may prevent you from being able to copy, back up, or copy back data properly.
- For details on docomo Data Copy, see the DOCOMO website.

Migrating data

Use direct 1-to-1 communication (not over the Internet) to copy contact entries, images, or other data directly to another device.

Activate "Data Copy" on both the device being copied from and the device being copied to and place them together.

- 1 In the home screen, [≡] ▶ [Tools] ▶ [Data Copy] ▶ [Data transfer]
 - Continue by following the instructions on the screen.
 - This app must be installed on both the device being copied from and the device being copied to. The app can be downloaded from the DOCOMO website.

Backup/Restore

Use a microSD Card to migrate contact entries, images, and other data or back up/copy back such data.

- Do not remove a microSD Card or power off the handset while backing up or copying back data. Doing so may corrupt data.
- Contact entries without a name registered cannot be backed up.
- If there is not enough free memory space on the handset or the microSD Card, it may prevent data from being backed up or copied back.
- With this app, only data (photos, videos, etc.) saved to the handset can be backed up. Data saved to a microSD card is not backed up.
- Regular back up is not carried out at the set time, such as if the Battery Saver is on, and is carried out the next time the app can activate.

Backup

Back up data such as contact entries and media files.

- 1 In the home screen, [≡] ▶ [Tools] ▶ [Data Copy] ▶ [Backup & Restore]
- 2 [Backup] ▶ [Start backup] ▶ [BACKUP]
 - The selected data is saved to microSD card.
- 3 [Back to top]

Restore

Copy data back to the handset that was backed up to a microSD Card such as contact entries, images, and other data.

- 1 In the home screen, [Menu] ▶ [Tools] ▶ [Data Copy] ▶ [Backup & Restore]
- 2 [Restore] ▶ [next] ▶ [Restore] ▶ [RESTORE]
 - The selected data is copied back to the terminal.
- 3 [Back to top]
 - If a regular backup schedule is not set, "Set a backup schedule" appears. Follow the instructions on the screen.

Copying contact entries to the docomo account

Copy contacts registered in a Google account and the handset to the docomo account.

- 1 In the home screen, [Menu] ▶ [Tools] ▶ [Data Copy] ▶ [Backup & Restore]
- 2 [Phonebook account copy] ▶ [Select] for the contacts to copy ▶ [OVERWRITE]/[ADD]
 - Copied contact entries are saved to the docomo account.
- 3 [OK]

Handset Settings

Settings menu

Make handset settings from the settings menu.

- Shown items and their arrangement may differ depending on current settings.

1 In the home screen, [⊞] ▶ [Settings]

Network & internet	Network & internet →P.62
Connected devices	Connected devices →P.65
Apps	Apps →P.65
Notifications	Notifications →P.66
Battery	Battery →P.66
Direct keys	Direct keys →P.30
Storage	Storage →P. 67
Sound & vibration	Sound & vibration →P.67
Display	Display →P.68
Wallpaper & style	Wallpaper & style →P. 68
Switch home app	Switch the Home app.
Accessibility	Accessibility→P. 68
Security	Security →P.69
Privacy	Privacy →P.72
Location	Location →P. 72
Safety & emergency	Safety & emergency →P. 72
docomo service/cloud	docomo service/cloud →P.73
Passwords & accounts	Passwords & accounts →P.73
Digital Wellbeing & parental controls	Digital Wellbeing & parental controls →P.74
Google	Google →P.74
System	System →P.74
About phone	About phone →P.75

NOTE

- Tap "Search settings" at the top of the settings screen to search for setting options.

Network & internet

Make Wi-Fi, home network, and other communication settings.

1 In the home screen, [⊞] ▶ [Settings] ▶ [Network & internet]

Internet	Check the mobile network, make Wi-Fi settings, etc. Internet →P.62 Wi-Fi →P. 62
SIMs	SIMs →P.63

Airplane mode	Airplane mode →P. 64
Dual SIM settings	Make settings when using two SIMs, such as the SIM used with priority for mobile data, calls, and SMS messaging.
Tethering	Tethering →P. 64
Data Saver	Data Saver →P.65
VPN	VPN →P. 65
Private DNS	Make private DNS settings.
Adaptive connectivity	Manage network connection automatically, to improve handset performance such as by extending battery life.

Internet

1 In the home screen, [⊞] ▶ [Settings] ▶ [Network & internet] ▶ [Internet]

- A settings screen for available mobile networks (SIM) and Wi-Fi is displayed.
- Tap a mobile network (SIM) to switch to mobile network connection.
- Tap  to the right of the mobile network (SIM) to check/make settings for the mobile network (SIM) (→P.63).

Wi-Fi

Connect to a home or office network or public wireless LAN service via an access point to use email and Internet, using handset Wi-Fi function.

■ Radio interference with Bluetooth devices

Wireless LAN (IEEE 802.11 b/g/n) and Bluetooth devices use the same frequency band (2.4 GHz). Using the handset near a Bluetooth device may cause interference, resulting in lower communication speed, noise, and poor connection. In this instance, do the following.

- Distance the handset and the Bluetooth device at least 10 m apart.
- If using the handset at less than 10 m, power off the Bluetooth device.

1 In the home screen, [⊞] ▶ [Settings] ▶ [Network & internet] ▶ [Internet]

2 Set "Wi-Fi" to ON

3 Select an access point

- If you select a security-protected access point, enter the password (security key) and tap "CONNECT".
- To register access points manually: [Add network] ▶ Enter the network name ▶ Set security ▶ [SAVE]
- To register access points with a QR code: [⊞] for "Add network" ▶ Aim handset camera at the QR code for the Wi-Fi network so it is displayed on the handset

NOTE

- Depending on your environment, communication may be slow or unavailable.

- You can also use packet communication when Wi-Fi is ON. If a Wi-Fi network is disconnected, the handset switches automatically to the mobile network. Note that continuing to use the handset with the connection switched may incur high packet communication fees.
- You can set the Wi-Fi function to OFF to reduce battery consumption.
- When using Wi-Fi, be sure to obtain an adequate signal.
- If you connect to an access point that is not connected to the Internet,  or other icon appears, and communication may be via the mobile network and not the Wi-Fi network.

Advanced Wi-Fi settings

- 1 In the home screen,  ► [Settings] ► [Network & internet] ► [Internet]
- 2 [Network preferences]

Turn on Wi-Fi automatically	Enable Wi-Fi to turn on automatically and connect if a high-quality, saved Wi-Fi network is detected. It is necessary to enable Location before setting to ON.
Notify for public networks	Enable a notification to appear if a high-quality public network is available.
Install certificates	Install certificates.
Wi-Fi Direct	Wi-Fi Direct →P. 63
Advanced Wi-Fi settings	Make settings such as scan interval, handover threshold, automatic mobile network switching, etc.

Wi-Fi Direct

Connect to other Wi-Fi Direct-capable devices with the Wi-Fi function without an access point or the Internet.

- Available when Wi-Fi is set to ON.

- 1 In the home screen,  ► [Settings] ► [Network & internet] ► [Internet]
- 2 [Network preferences] ► [Wi-Fi Direct]
 - Continue by following the instructions on the screen.

Deleting access point settings

- 1 In the home screen,  ► [Settings] ► [Network & internet] ► [Internet]
- 2 Select the connected access point ► [FORGET] (Delete)

SIMs

Make settings for the calling mode, access points, etc.

- Tap "+" to the right of SIMs to make eSIM settings. For eSIM settings, see "Setting SIM information for an eSIM" (→P.63).

- Note that simultaneous use of the nano SIM card and an eSIM may cause services or functions that you use to be restricted.

- 1 In the home screen,  ► [Settings] ► [Network & internet]
- 2 [SIMs]
- 3 Set "Use SIM" to ON

XXMB used	Data usage over the mobile network, etc. is displayed.
Calls preference	Set the SIM used when making a call.
SMS preference	Set the SIM used when sending SMS.
Mobile data	Enable access to data via the mobile network.
Data roaming	Data roaming →P.80
App data usage	Display data used via the mobile network as a graph, and check apps that used the mobile network.
Data warning & limit	Data warning & limit →P.63
Preferred network type	Preferred network type →P.81
Automatically select network	Automatically selecting a network →P.80
Choose network	If "Automatically select network" is set OFF, the handset searches for available networks.
Access Point Names	Set and check access points.

NOTE

- In the SIM settings screen, tap  to check/edit the SIM name and color.

Setting SIM information in the eSIM

The first time you use an eSIM, you must download and set SIM information necessary for communication.

- 1 In the home screen,  ► [Settings] ► [Network & internet] ► [+] to the right of SIMs
- 2 [Download a SIM instead?] ► [Next]
 - Continue by following the instructions on the screen.

Data warning & limit

Set a monthly meter-start day, an amount of data usage to alert you at, and other settings for data usage via the mobile network.

- 1 In the home screen,  ► [Settings] ► [Network & internet] ► [SIMs]
- 2 [Data warning & limit]

Mobile data usage cycle	Set the date on which the usage cycle resets for mobile data usage.
-------------------------	---

Set data warning	Enable the handset to alert you when mobile data usage reaches the set warning level.
Data warning	Set a warning level on mobile data usage.
Set data limit	Set mobile data to stop temporarily when mobile data usage reaches the set upper limit.
Data limit	Set an upper limit on mobile data usage.

NOTE

- If data reaches the "Data limit" and you are no longer able to use data, in the Data warning & limit screen, set "Set data limit" to OFF or change the upper limit in "Data limit" to resume using data. Alternatively, if "Data is paused" is displayed, tap "RESUME" to resume using data.

Setting an access point

Access points for connecting to the Internet (docomo) are pre-registered. Add or change access points as required.

■ Checking the access point that is currently used

- 1 In the home screen, [⌘] ▶ [Settings] ▶ [Network & internet] ▶ [SIMs] ▶ [Access Point Names]

■ Setting additional access points <new APN>

- 1 In the home screen, [⌘] ▶ [Settings] ▶ [Network & internet] ▶ [SIMs] ▶ [Access Point Names]
- 2 [+]
- To edit an access point, tap the access point.
- 3 [Name] ▶ Enter the name of the network profile to create ▶ [OK]
- 4 [APN] ▶ Enter the access point name ▶ [OK]
- 5 Enter any other items required by the carrier ▶ [OK]
 - Do not change MCC to a value other than 440, or MNC to a value other than 10. They will no longer appear on the screen.
- 6 [:] ▶ [Save]

NOTE

- If the MCC or MNC settings are changed and they no longer appear on the screen, either reset the handset to its initial settings, or set access points manually.

Resetting access points

Initializing access points returns them to their settings at time of purchase.

- 1 In the home screen, [⌘] ▶ [Settings] ▶ [Network & internet] ▶ [SIMs] ▶

[Access Point Names]

- 2 [:] ▶ [Reset to default]

Airplane mode

Restrict the use of some functions using communication such as call/mail functions.

- 1 In the home screen, [⌘] ▶ [Settings] ▶ [Network & internet]
- 2 Set "Airplane mode" to ON

NOTE

Airplane mode

- If "SIM card lock" is enabled, you cannot call an emergency number (110, 119, or 118). If it is disabled, you can call an emergency number (110, 119, or 118) even in Airplane mode. If you call an emergency number, "Airplane mode" is disabled and the call is made.
- The "Wi-Fi", "Bluetooth", and "NFC/Osaifu-Keitai" functions can be set to ON even when "Airplane mode" is enabled.

Tethering

You can use the tethering function to connect Wi-Fi devices as well as PCs, etc. connected via a USB cable or Bluetooth to the Internet by using the handset as an access point.

- Connect up to 20 devices at the same time: 15 Wi-Fi devices, 1 PC connected via a USB cable, and 4 Bluetooth devices.
- Before using Bluetooth tethering, register the other Bluetooth device in advance (→P.77). For settings on the Bluetooth device, see the instructions for the Bluetooth device.
- Subscription to a packet pack/flat-rate packet plan is strongly recommended for using tethering.

- 1 In the home screen, [⌘] ▶ [Settings] ▶ [Network & internet]
- 2 [Tethering]

Wi-Fi tethering	Enable Wi-Fi tethering and make settings for access point names, security, etc.
USB tethering	Enable USB tethering.
Bluetooth tethering	Enable Bluetooth tethering.

NOTE

USB tethering

- Tethering is available when the PC's OS is Windows 10 or Windows 11.
- Handset storage as well as a microSD card inserted in the handset cannot be mounted on a PC during USB tethering.

Data Saver

Limit mobile data in the background by apps and control data usage.

- 1 In the home screen, [⊞] ▶ [Settings] ▶ [Network & internet]
- 2 [Data Saver]
- 3 Set "Use Data Saver" to ON

NOTE

- Even when "Use Data Saver" is set to ON, apps that have been individually set with "Unrestricted data" can still be used with unrestricted mobile data.

VPN (Virtual Private Network)

VPN (Virtual Private Network) is a connection method to prepare and connect safely to a virtual dedicated line on the network of a household PC or in an office from outside, etc.

- Obtain required security details from your network administrator to set the VPN connection from the handset.

Adding a VPN

- 1 In the home screen, [⊞] ▶ [Settings] ▶ [Network & internet] ▶ [VPN]
- 2 [+]
- 3 Set each item ▶ [SAVE]

Connecting a VPN

- 1 In the home screen, [⊞] ▶ [Settings] ▶ [Network & internet] ▶ [VPN]
- 2 Select a VPN to connect to
- 3 Enter information for connecting to the VPN ▶ [CONNECT]

Disconnecting a VPN

- 1 In the home screen, [⊞] ▶ [Settings] ▶ [Network & internet] ▶ [VPN]
- 2 Select the VPN to disconnect from ▶ [CANCEL]

Connected devices

- 1 In the home screen, [⊞] ▶ [Settings] ▶ [Connected devices]

USB	Set operation when connected to a PC via a USB cable. <ul style="list-style-type: none">• Displayed when the handset is connected to a PC with a USB cable.
Pair new device	Pair with an available Bluetooth device. Using the Bluetooth function →P.77
Saved devices	Devices the handset has paired with before are displayed.
See all	All devices the handset has paired with before are displayed.
Connection preferences	Connection preferences →P.65

Connection preferences

- 1 In the home screen, [⊞] ▶ [Settings] ▶ [Connected devices]
- 2 [Connection preferences]

Bluetooth	Bluetooth function →P.77
NFC/Osaifu-Keitai	NFC/Osaifu-Keitai function →P.55
Cast	Connect your Google Cast model to share screen and audio to another device.
Printing	Set a printer using a default printing service, or install a printing service.
Chromebook	Connect with a Chromebook
Nearby Share	Share files with other nearby devices.
Android Auto	Connect to your car screen to use apps and Google services while in the car.

Apps

Make individual app settings for notifications, permissions, default app, etc.

- 1 In the home screen, [⊞] ▶ [Settings] ▶ [Apps]

Recently opened apps	Recently opened apps (app information) →P.66
See all XX apps	See all XX apps (app information) →P.66
Default apps	Set default browser app, home app, phone app, SMS app, etc.
Screen time	Display handset usage time and app usage time.
Unused apps	Check apps that are not being used.

Special app access	Check/change settings for apps, etc. that access handset functions and information.
---------------------------	---

App information

You can check names, memory usage, versions, etc. of apps, enable/disable apps, uninstall them, etc.

- 1 In the home screen, [⊞] ▶ [Settings] ▶ [Apps]
- 2 [See all XX apps] ▶ Select the app

Disabling/enabling an app

End operation of an app and remove it from the app screen without uninstalling it.

- You can disable apps which cannot be uninstalled.

- 1 In the home screen, [⊞] ▶ [Settings] ▶ [Apps]
- 2 [See all XX apps] ▶ Select the app
- 3 [DISABLE] ▶ [DISABLE APP]
 - Tap "ENABLE" to activate.

Notifications

Make notification settings.

- 1 In the home screen, [⊞] ▶ [Settings] ▶ [Notifications]

App settings	Set notifications from apps.
Notification history	View a history of notifications displayed in the notifications panel
Conversations	Display priority conversations and conversations with changed settings.
Bubbles	Enable floating icons for notification of new messages from specified parties.
Device & app notifications	Set apps and devices that can read notifications.
Notifications on lock screen	Set details of notifications are shown in the start screen.
Sensitive notifications	Enable details of notifications in the lock screen to be displayed when the method for unlocking the screen is set to a method other than "None" and "Swipe".
Do Not Disturb	Make Do Not Disturb settings.
Wireless emergency alerts	Make settings for emergency alerts.
Hide silent notifications in status bar	Enable silent notifications to be displayed in the status bar.
Allow notification snoozing	Enable snoozing of notifications.

Notification dot on app icon	Enable a dots to be displayed on icons to notify you of app notifications.
Blink light	Enable the charging lamp to flash to notify you of notifications for missed calls, etc.
Enhanced notifications	Enable suggestions for actions, replies, etc.

* Shown items may differ depending on current usage.

Battery

Check battery usage, make Battery Saver settings, etc.

- 1 In the home screen, [⊞] ▶ [Settings] ▶ [Battery]

XX%	Battery level, available usage time (approximate), etc. are displayed.
Battery usage	Check battery usage from the last full charge, and set how the battery is used by individual apps.
Battery Saver	Control battery consumption by setting the "Battery Saver". To set the Battery Saver to ON manually, set "Use Battery Saver" to ON. Select "Based on percentage" in "Set a schedule" and you can enable the Battery Saver to turn on according to the battery level. Set "Turn off when charged" to "ON" to set the Battery Saver to OFF when the battery is charged to 90%.
Adaptive Battery	Enable battery usage of seldom-used apps to be automatically adjusted.
Battery percentage	Enable battery strength (%) to be shown on the status bar.
Battery Care Mode	Set "Battery Care Mode" to ON to stop charging when the battery is charged to 85% and extend battery pack life. However, "100%" is displayed for the battery level. Usable time per one charge is shorter. <ul style="list-style-type: none"> • When Battery Care Mode is set, a heart mark  is displayed on the battery icon.
Battery swap	Set use of battery swap (→P.20). Check how data pertaining to usage is used (information collection) and check the condition of the internal battery.

NOTE

- When the battery level is 90% or more, battery usage per each app resets when you either end charging or restart the handset

Storage

Check usage of handset internal storage and a microSD card, as well as mount and unmount microSD cards.

- In the home screen, [⌘] ▶ [Settings] ▶ [Storage]

THIS DEVICE	Displayed when a microSD card or USB storage is installed. Tap [THIS DEVICE] ▶ [SD CARD]/[USB drive] and a storage screen for microSD card/USB storage is displayed.
XX used	Used space/total space in internal storage is displayed.
Free up space	Delete files and increase free space in internal storage.
System / Apps / Images / Trash / Documents & other / Games / Audio / Videos*	Check and manage space used by each function.

* Shown items may differ depending on current usage.

NOTE

Mounting/unmounting microSD cards/USB drive

- To mount a microSD card/USB drive: [SD CARD] / [USB drive] ▶ [⋮] ▶ [Mount]
- To unmount a microSD card/USB drive: [SD CARD] / [USB drive] ▶ [⋮] ▶ [Eject]

Formatting microSD cards/USB drive

- To format a microSD card/USB drive:[SD CARD] / [USB drive] ▶ [⋮] ▶ [Format] ▶ [FORMAT SD CARD] / [FORMAT USB DRIVE]
- All data on a microSD card/USB drive will be deleted when formatted. Use caution.

Sound & vibration

Make settings for ringtones, vibration, etc.

- In the home screen, [⌘] ▶ [Settings] ▶ [Sound & vibration]

Media volume	Adjusting volume for each type of media →P.67
Call volume	
Ring & notification volume	
Alarm volume	
Manner mode	Manner mode →P.68

Phone ringtone	Set a ringtone.
Live Caption	Enable captions when audio is detected.
Media	Enable the media player to be continuously displayed in the Quick Settings panel.
Vibration pattern	Set the vibration pattern.
Vibration & haptics	Set the vibration level, etc.
Default notification sound	Set a standard notification ringtone.
Default alarm sound	Set a standard alarm sound.
Dial pad tones	Enable tones to be emitted when using the dial pad.
Screen locking sound	Enable a tone to be emitted when sliding the start screen or unlocking the screen. A tone is also emitted when pressing  (power button) to enter sleep mode.
Charging sounds and vibration	Enable a tone to be emitted and the handset to vibrate at the start of charging.
Charged sounds and vibration	Enable a tone to be emitted and the handset to vibrate at the completion of charging.
Touch sounds	Enable tones to be emitted when using the touch operation on the screen.
Do Not Disturb	Set Do Not Disturb mode ON/OFF. When Do Not Disturb is set to ON, you can set when notification sounds for each type of notification sound, the time frame when notifications are made, etc.

Adjusting volume for each type of media

Adjust the volume for media, calls, ringtone/notification ringtone, and alarms.

- In the home screen, [⌘] ▶ [Settings] ▶ [Sound & vibration]
- Drag the slider left/right for "Media volume" / "Call volume" / "Ring & notification volume" / "Alarm volume" to adjust volume

Manner mode type

- 1 In the home screen, [⌘] ▶ [Settings] ▶ [Sound & vibration] ▶ [Manner mode]

Vibrate	Ringtones and other handset sounds are muted; handset vibrates for incoming calls/messages, etc.
Mute	Ringtones and other handset sounds are muted; handset does not vibrate for incoming calls/messages, etc.
Drive	Ringtones and other handset sounds are muted; handset does not vibrate for incoming calls/messages, etc. When a call arrives, auto answering activates and a message plays to indicate that you are driving.

Display

Make settings for screen display, etc.

- 1 In the home screen, [⌘] ▶ [Settings] ▶ [Display]

Brightness level	Set the screen brightness.
Adaptive brightness	Enable the screen to automatically adjust its brightness to the surrounding brightness.
Lock screen	Make settings for information displayed in the lock screen.
Screen timeout	Set the time until the handset enters sleep mode.
Keep screen on while holding	Set the screen to remain on while held in your hand.
Dark theme	Change to a black-toned screen. To set Dark theme to ON, set "Use Dark theme" to ON. You can set Dark theme to become set to ON for the time specified with "Schedule" or from sunrise to sunset times.
Screen saver	Set the type of screen save and when it activates.
Display size and text	Set the size of screen text, size of displayed items, etc.
Night Light	Set a yellowish hue for an easier-to-see screen under dim lighting. To set Night Light to ON, set "Use Night Light" to ON. You can set Night Light to set to ON for the time specified with "Schedule" or from sunrise to sunset times.
Glove touch mode	Glove touch mode →P.68

Pocket mode	Set the handset to disable touch operation and prevent unintentional operation when the screen is on and the proximity sensor becomes covered.
Auto-rotate screen	Auto-rotate screen →P.30
Display quick settings	Enable Quick Settings panel to be displayed in the notifications panel.

Glove touch mode

Set glove touch mode to ON to enable detection of touch operation while wearing gloves.

- 1 In the home screen, [⌘] ▶ [Settings] ▶ [Display]
- 2 [Glove touch mode] ▶ Set "Use Glove touch mode" to ON

Wallpaper & Style

Set the wallpaper, theme color, etc. for the home screen and lock screen.

- 1 In the home screen, [⌘] ▶ [Settings] ▶ [Wallpaper & style]

Change wallpaper	Change wallpaper to a selected image.
Wallpaper colors/Basic colors	Set either a color palette based on the wallpaper colors or the basic screen display colors. <ul style="list-style-type: none"> • Compatible screens, apps, etc. are automatically customized to appear in colors according to the selected color palette/basic colors.
Dark theme	Change to a black-toned screen display. To set Dark theme to ON, set "Use Dark theme" to ON. You can set Dark theme to become set to ON for the time specified with "Schedule" or from sunrise to sunset times.
Themed icons	Enable compatible app icons to be displayed in monotone. <ul style="list-style-type: none"> • This set to a color matching the selected color palette/basic colors or the Dark theme.



Accessibility

- 1 In the home screen, [⌘] ▶ [Settings] ▶ [Accessibility]

Select to Speak	Enable handset to read out selected text.
-----------------	---

TalkBack	Enable handset to read out onscreen items.
Display size and text	Set the size of screen text, size of displayed items, etc.
Color and motion	Set color (color correction, inverted colors, Dark mode) and movement (animation, mouse pointer).
Extra dim	Enable the screen to be dimmed more than the settable lowest level of brightness.
Magnification	Set a shortcut for enlarging the screen and how to enlarge.
Accessibility Menu	Enable a larger screen menu to be displayed.
Switch Access	Enable an external switching device to be connected for operating the handset.
Vibration & haptics	Set handset vibration intensity for ringtone, notifications, and tap operation.
Timing controls	Make settings for operational timings, such as the interval between deleting touch & hold operation and display time for messages.
System controls	Make handset operation settings such as system navigation and how to rotate the screen. <ul style="list-style-type: none"> • Set "Power button ends call" to ON to enable ending a call with  (power button).
Live Caption	Enable captions when audio is detected.
Caption preferences	Enable captions for apps that support captioning.
Audio description	Enable descriptions of onscreen content to be read out for movies and programs.
Audio adjustment	Set channel and left-right volume balance when playing back audio.
Accessibility shortcuts	Set shortcuts for quickly accessing accessibility functions.
Text-to-speech output	Text-to-speech output →P.74

NOTE

- Even if "Power button ends call" is ON and the handset enters sleep mode during a call, pressing  (power button) does not end the call, and the handset exits sleep mode. Press  (power button) while the screen is on to end a call.

Security

- 1 In the home screen,  ► [Settings] ► [Security]

Google Play Protect	Enable regular checking for unauthorized operation of apps or the handset.
Find My Device	Enable remote searching of the handset's current location, etc.
Security update	Check for security updates and update.
Google Play system update	Check for updates and update.
Screen lock	Screen lock →P.70
Face & Fingerprint Unlock	Fingerprint Unlock →P.70 Face Unlock →P.71
More security settings	More security settings →P.69

* Shown items may differ depending on current usage.

More security settings

- 1 In the home screen,  ► [Settings] ► [Security] ► [More security settings]

Smart Lock	Enable the screen to automatically unlock for trusted devices or places you have registered, or when the handset detects that it is being carried with a "Smart Lock". Set the method for unlocking the screen to a method other than "None" and "Swipe".
Device admin apps	Enable or disable device administration apps.
SIM card lock	SIM card lock →P.28
Encryption & credentials	Encryption & credentials →P.71
Trust agents	Manage trust agents (functions such as Smart Lock). Set the method for unlocking the screen to a method other than "None" and "Swipe".
App pinning	Set to keep only screen of a specified app in view. <ul style="list-style-type: none"> • You can also enable the start screen to be displayed when unpinning a screen after setting "Use App pinning" to ON.
Confirm SIM deletion	Set the handset to verify your identity before deleting an eSIM. Set the method for unlocking the screen to a method other than "None" and "Swipe".

Setting a method for unlocking the screen

Set a method for unlocking the screen when powering on the handset or exiting sleep mode.

- 1 In the home screen, [⊞] ▶ [Settings] ▶ [Security] ▶ [Screen lock]
- 2 [Pattern] / [PIN] / [Password]
 - Continue by following the instructions on the screen.

NOTE

- The lock screen is displayed when about to make settings when the screen lock is set to "Pattern", "PIN", or "Password". Unlock it with the set method.
- Entering an incorrect "Pattern", "PIN", or "Password" 5 consecutive times prevents the screen from being unlocked. Wait for 30 seconds and enter the method again to unlock the screen.
- "⚙️" is displayed next to "Screen lock" when the screen lock is set to "Pattern", "PIN", or "Password". Tap "⚙️" to set the following items.
 - Make pattern visible
Display the traced lines when the pattern is input. Displayed when the screen lock is set to "Pattern".
 - Lock after screen timeout
Set the time until the screen locks after the screen turns off.
 - Power button instantly locks
Enable the screen to lock immediately after pressing  (power button) to turn the screen off.
 - Interlock with screen timeout
Set the lock screen to turn off with the time set until the screen turns off.
 - Erase data
Set all data in handset memory to be reset if an incorrect "Pattern", "PIN", or "Password" is entered the set number of tries.
- If you forget the set "Pattern", "PIN", or "Password", contact a docomo Shop.

Fingerprint Unlock

Handset fingerprint sensor allows you register a finger and authenticate your fingerprint to unlock the screen.

Precautions when using Fingerprint Unlock

- Fingerprint Unlock uses your fingerprints' characteristics, and may be unusable if your fingerprint characteristics are not prominent.
- Ability to authenticate (assuming finger is touching the sensor correctly) depends on conditions of use. Saving a fingerprint may be difficult if the finger is in any of the following conditions. Wiping/washing hands, using different finger, registering a wide area of the finger, etc. may improve capability.
 - Wrinkled after a bath or wet
 - Sweaty or covered with oil (handcream, etc.)
 - Soiled with mud or grease

- Rough or damaged (cut, sore, etc.)
- Extremely dry
- Fingerprint is deformed due to weight gain or loss
- Fingerprint is faint (finger surface is worn)
- Finger texture at the time of authentication is extremely different than when fingerprint was saved
- Fingerprint authentication technology does not guarantee successful personal authentication/verification. DOCOMO is not liable for any damages resulting from use of the handset by a third party or lost opportunities to use the handset.

Precautions when using the fingerprint sensor

- Do not hit or subject the sensor to excessive shock. Do not scratch the sensor or poke it with a pointed object. Doing so may cause malfunction or damage.
- Do not place stickers on the sensor or mark on it with ink.
- Soiling on sensor may affect authentication. Clean the fingerprint sensor surface with a soft cloth from time to time.

Registering fingerprints

Register your fingerprints for Fingerprint Unlock.

- Save up to 5 fingerprints.
- If authentication fails, using a different finger may improve authentication performance.
- Set the method for unlocking the screen to a method other than "None" and "Swipe".

- 1 In the home screen, [⊞] ▶ [Settings] ▶ [Security] ▶ [Face & Fingerprint Unlock]
- 2 Enter the "Pattern", "PIN", or "Password" to unlock the screen
- 3 [Fingerprint]
 - Continue by following the instructions on the screen.
 - After registering a fingerprint, a notification appears indicating a fingerprint was added. You can tap "Add another" to register another fingerprint.

NOTE

- Use the following operations in the fingerprint settings screen.
 - Change the name of a fingerprint
Tap a registered fingerprint ▶ Enter a name ▶ [OK]
 - Delete a fingerprint
[⊞] for a registered fingerprint ▶ [DELETE]
 - Set fingerprints to authenticate when the screen is off
Set "Fingerprint always on" to ON to enable fingerprints to authenticate while the screen is off.

Authenticating with fingerprints

- 1 While the start screen is displayed, touch the sensor with a registered finger.

- Slide the start screen up, and a screen is displayed for entering a method for unlocking the screen.

NOTE

- If the handset does not authenticate your fingerprint 5 consecutive times, the handset stops authenticating. Either wait a while and authenticate with your fingerprint again, or slide the start screen up and unlock with the set unlock method.

Face Unlock

Precautions when using Face Unlock

- Face Unlock does not provide the same level of security as other lock methods (pattern, PIN, password, etc.).
- Ability to authenticate (when your face is authenticated facing the in-camera) differs with the conditions you are using the handset in.
- Note the following when registering your face to ensure optimal authentication.
 - Register your face in a bright location. Avoid registering your face in back-lit conditions.
 - Do not allow clothing, your hair, sunglasses, a mask, etc. to cover your face.
 - Photograph with your face straight on with the camera, with a normal expression, and with your entire face in the guides around the registration area. Do not move your head or close your eyes.
- Observe the following when using face unlock in the start screen.
 - Face Unlock may fail in an extremely dark, bright, or back-lit conditions.
 - Face Unlock may fail if clothing, your hair, sunglasses, a mask, etc. is allowed to cover your face entirely or partially.
 - Face Unlock may fail if your face is at an angle.
 - The screen may become unlocked with someone or an object that resembles you.

Registering your face

Register a face to use with face unlock.

- Set the method for unlocking the screen to a method other than "None" and "Swipe".
- 1 In the home screen, [⊞] ▶ [Settings] ▶ [Security] ▶ [Face & Fingerprint Unlock]
 - 2 Enter the "Pattern", "PIN", or "Password" to unlock the screen
 - 3 [Face Unlock]
 - 4 [I agree]
 - Checkmark "Lift to wake up the device" to enable "Lift to wake" (→P.74).
 - 5 [Start]
 - Continue by following the instructions on the screen.

Authenticating with your face

- 1 While the start screen is displayed, face the in-camera

- If the handset does not authenticate you properly, change the angle or distance of your face.

NOTE

- If the handset does not authenticate your face 5 consecutive times, the handset stops authenticating. Either wait a while and authenticate with your face again, or slide the start screen up and unlock with the set unlock method.

Encryption & credentials

Check and set encryption of the handset and SD card as well as check credentials.

- 1 In the home screen, [⊞] ▶ [Settings] ▶ [Security]
- 2 [More security settings] ▶ [Encryption & credentials]

Encrypt phone	Internal storage is encrypted at time of purchase.
Encrypt SD card	Encrypt SD card →P.71
Trusted credentials	Display trusted CA certificates.
User credentials	Manage user credentials saved on the handset.
Install a certificate	Install a certificate from a microSD card.
Clear credentials	Delete all credentials.
Certificate management app	Set a certificate management app.

Encrypting/decrypting an SD card

Data saved to a microSD card after it had been encrypted cannot be used on any device other than the one used for encrypting the card.

To use the microSD card normally, decrypt the card.

- Charge handset adequately beforehand, and keep handset charged during the process.
 - Set a [PIN] or [Password] for the screen lock in advance (→P.70).
- 1 In the home screen, [⊞] ▶ [Settings] ▶ [Security]
 - 2 [More security settings] ▶ [Encryption & credentials] ▶ [Encrypt SD card]
 - 3 [NEXT] ▶ Enter the PIN or password
 - 4 [ENCRYPT]/[DECRYPT]

NOTE

- Note that if you have used [Erase all data (factory reset)] with a microSD card encrypted, you can no longer use the data on the card. Decrypt the card before using [Erase all data (factory reset)].

Privacy

Make settings for permissions, account activity, etc.

- 1 In the home screen, [⌘] ▶ [Settings] ▶ [Privacy]

Privacy dashboard	Check apps recently using permissions, and change permission settings.
Permission manager	Check/change settings for app permissions.
Camera access	Set camera access permission for apps and services.
Microphone access	Set mic access permission for apps and services. <ul style="list-style-type: none"> • Even when "Microphone access" is set to OFF, data from the mic may be shared when calling an emergency number.
Show passwords	Enable entered characters to be visible before changing to "●" in an entry window for a PIN/ password.
Notifications on lock screen	Set details of notifications are shown in the start screen.
Android System Intelligence	Set suggestions based on learned information, etc. to appear in the keyboard candidates list, and delete learned content.
App content	Permit apps to send content to the Android system.
Show clipboard access	Enable a message notification to be displayed for apps accessing text, images, etc. copied to the clipboard.
Autofill service from Google	Check saved information, and change settings.
Activity controls	Enable activity, and select activities and information that are savable to Google.
Ads	Reset ad IDs, and set ad IDs not to be used.
Usage & diagnostics	Usage & diagnostics Google.

Location

- 1 In the home screen, [⌘] ▶ [Settings] ▶ [Location]
- 2 Set "Use location" to ON

Recent access	Display apps and services using latest location information.
See all	Display all apps and services using latest location data.

App location permissions	Check/change permission of apps using location information, and permit use of accurate location information.
Location services	Location services →P.72

NOTE

Using location (GPS function)

- To save on battery consumption, set "Use location" to OFF.
- Locationing is more accurate in a location where there are no surrounding buildings and the sky is visible. If your surroundings are preventing you from obtaining an accurate location, move to where the sky is visible.

Location services

- 1 In the home screen, [⌘] ▶ [Settings] ▶ [Location]
- 2 [Location services]

Earthquake alerts*	Enable use of earthquake alerts.
Emergency Location Service	Enable use of Emergency Location Service
Google Location Accuracy	Enable use of Wi-Fi, mobile networks, etc. to increase the accuracy of location information.
Google Location History	Set use of Google location history, and manage saved activity.
Google Location Sharing	Check sharing of current location, and disable sharing.
Wi-Fi scanning	Permit scanning of Wi-Fi networks even while the Wi-Fi function is OFF.
Bluetooth scanning	Permit scanning of Bluetooth devices even while the Bluetooth function is OFF.

* Shown items may differ depending on current usage.

Safety & emergency

- 1 In the home screen, [⌘] ▶ [Settings] ▶ [Safety & emergency]

OPEN PERSONAL SAFETY	Set/display emergency information services.
Medical information	Register/check medical information.
Emergency contacts	Add/check emergency contact information.

Emergency SOS	Enable emergency SOS, and set handset action when an emergency SOS is used.
Crisis alerts	Enable use of disaster alerts.
Emergency Location Service	Enable use of Emergency Location Service
Earthquake alerts*	Enable use of earthquake alerts.
Wireless emergency alerts	Set early warning "Area Mail".

* Shown items may differ depending on current usage.

docomo service/cloud

- 1 In the home screen, [⌘] ▶ [Settings] ▶ [docomo service/cloud]

d ACCOUNT setting	Make d ACCOUNT settings for use with DOCOMO apps. You can also make settings for d ACCOUNT authentication using biometrics (fingerprints) registered on the handset.
docomo Application Data Backup	Enable automatic backing up/restoring of docomo app data, and check a listing of apps with backed up data.
docomo apps management	Manage docomo apps and make settings for notifications and automatic updates.
Osusume Apps	Make settings for recommended Osusume apps, and check past received notifications.
docomo location information	Make settings for imadoco search and Keitai Osagashi Service functions.
Send device information	Set handset information to be sent to a DOCOMO-managed server.
Member/profile settings	Check/change membership and profile information used by DOCOMO services.
docomo initial settings	Make initial settings for docomo services.
Switch USB debugging	Settings for use with a special terminal such as at a docomo Shop.
Open source licenses	Display open source licenses.

NOTE

- Some apps appearing in docomo service/cloud can be disabled. After being disabled, an app may no longer appear in the docomo service/cloud list. A newly downloaded app provided by DOCOMO may appear in the docomo service/cloud list as an added item.

Passwords & accounts

- 1 In the home screen, [⌘] ▶ [Settings] ▶ [Passwords & accounts]

Passwords	Set the Password Manager
Autofill service	Select and set the autofill service.
Add account	Adding an account →P.73
Automatically sync app data	Automatically sync app data →P.73

Add account

Add and delete accounts for online services.

- Settings for Google and other such accounts →P.27

- 1 In the home screen, [⌘] ▶ [Settings] ▶ [Passwords & accounts]

- 2 [Add account]

- 3 Tap the account type

- Continue by following the instructions on the screen.

NOTE

- The docomo account is set at the time of purchase.

Deleting accounts

- 1 In the home screen, [⌘] ▶ [Settings] ▶ [Passwords & accounts]

- 2 Select the account to delete

- 3 [REMOVE ACCOUNT] ▶ [REMOVE ACCOUNT]

NOTE

- The docomo account cannot be deleted.

Setting automatic account syncing

Enable automatic syncing of information on the handset and an online service. You can display and edit information from either the handset or a PC.

- After automatic syncing is set, transmission occurs when syncing, and may incur packet communication fees.

- 1 In the home screen, [⌘] ▶ [Settings] ▶ [Passwords & accounts]

- 2 Set "Automatically sync app data" to ON ▶ [OK]

Syncing manually

If "Automatically sync app data" is set to OFF, selected items can be synced manually.

- Syncing may not be possible depending on the type of accounts.

- 1 In the home screen, [⌘] ▶ [Settings] ▶ [Passwords & accounts]
- 2 Select the account
- 3 [Account sync] ▶ Select the items to sync

Digital Wellbeing & parental controls

Check handset use habits, and use an app timer, etc. to manage usage and prevent excessive use. Also set controls on usage as a parent/guardian.

- 1 In the home screen, [⌘] ▶ [Settings] ▶ [Digital Wellbeing & parental controls]
- 2 Set each item
 - Continue by following the instructions on the screen.

Google

Check, change, or delete information and settings for your Google account and services.

- 1 In the home screen, [⌘] ▶ [Settings] ▶ [Google]
- 2 Set each item
 - Continue by following the instructions on the screen.

System

- 1 In the home screen, [⌘] ▶ [Settings] ▶ [System]

Languages & input	Languages and input →P.74
Gestures	Gestures →P.74
Date & time	Date and time →P.74
Auto power on/off	Set times for the handset to power on/off automatically.
Auto power on	Enable the handset to power on automatically if charging is started while powered off.
Backup	Enable automatic backup of app data, handset settings, etc. using a Google account.
System update	System update (software update) →P.87
Reset options	Reset options →P.75

Languages & input



- 1 In the home screen, [⌘] ▶ [Settings] ▶ [System]
- 2 [Languages & input]

Languages	Switch between Japanese and English displays. <ul style="list-style-type: none"> • Activated apps may exit.
App Languages	Set language per individual app.
On-screen keyboard	Make settings for the character entry software.
Physical keyboard	Make settings for the keyboard connected via Bluetooth or other connection.
Voice input	Make settings for Google Voice Input
Text-to-speech output	Make settings for audio when reading out text on the handset.
Spell checker	Enable use of a spell checker.
Personal dictionary	Save words.
Pointer speed	Set the pointer reaction speed when using a pointing device.

Gestures

Make settings for handset action when  (power button) is pressed, etc.

- 1 In the home screen, [⌘] ▶ [Settings] ▶ [System]
- 2 [Gestures]

Quickly open camera	Enable the camera to activate by pressing  (power button) twice.
System navigation	Make settings for screen return, moving to home, and switching apps.
Lift to wake	Enable the display to turn on when the handset is picked up.
One-handed mode	Set a smaller screen mode for use with one hand.
Press and hold power button	Enable long-pressing  (power button) to activate Google Assistant, etc.

Date & time

- 1 In the home screen, [⌘] ▶ [Settings] ▶ [System]
- 2 [Date & time]

Set time automatically	Enable usage of date/time information from the network to automatically correct the date and time.
Date	Set the date manually.
Time	Set the time manually.
Set time zone automatically	Enable usage of time zone information from the network to automatically correct the time zone.
Use location to set time zone	Enable use of location information in time zone setting.

Time zone	Set the time zone manually.
Use locale default	Enable the time display format to switch automatically according to your language/region.
Use 24-hour format	Switch manually between 12-hour and 24-hour formats.

NOTE

Network-provided time

- If the handset does not adjust the time for a while after being powered on, turn power off the handset and restart it.
- Time may not be adjusted depending on signal conditions.
- The clock may gain or lose a few seconds.

Reset options

1 In the home screen, [⊞] ► [Settings] ► [System]

2 [Reset options]

Reset Wi-Fi, mobile & Bluetooth	Reset all Wi-Fi, mobile data, and Bluetooth settings.
Reset app preferences	Reset information that has been set in apps.
Erase downloaded SIMs	Delete eSIM information.
Erase all data (factory reset)	Erase all data in handset memory and restore the handset to its state at the time of purchase.

NOTE

Erase all data (factory reset)

- The following data are erased.
 - Google account
 - System and app data settings
 - Downloaded apps
 - Music
 - Photos
 - Other user data

About phone

1 In the home screen, [⊞] ► [Settings] ► [About phone]

Device name	Change handset name.
Phone number (sim slot 1)/ Phone number (sim slot 2)	Check phone number.
Legal information	Check terms of use and other legal information.
Compliance information	Check compliance information.
SIM status (sim slot 1)/ SIM status (sim slot 2)	Check the SIM status.
Model	Check version and number.
IMEI (sim slot 1)/IMEI (sim slot 2)	
Android version	
IP address	
Wi-Fi MAC address	
Device Wi-Fi MAC address	
Bluetooth address	
Up time	
Build number	

Managing Files

Memory storage

Handset memory (internal storage)

The folder structure of handset memory (/storage/emulated/0) and data saved in the folders at time of purchase are as follows.

- Shown folders may differ depending on how the handset is operated.

Alarms	Alarm tones etc. are saved.
Android	App data, etc. are saved.
Audiobooks	Audiobooks, etc. are saved.
DCIM	Images and videos are saved.
Documents	Text data, etc. is saved.
Download	Files downloaded on web browser are saved.
Movies	Videos, etc. are saved.
Music	Music data, etc. is saved.
Notifications	Notification sounds, etc. are saved.
Pictures	Still pictures, etc. are saved.
Podcasts	Music data, etc. transferred from podcasts is saved.
Recordings	Recorded data, etc. is saved.
Ringtones	Ringtones, etc. are saved.

microSD card (external storage)

You can save data on the handset to a microSD card or import data on a microSD card to the handset.

- microSD card →P.22

Working with files

File and folder operations

Use the "Files" app to work with files saved in internal storage or on microSD card.

- 1 In the home screen, [Google] ▶ [Files]
 - Recently used files, categories, collections, and storage devices are displayed.
- 2 In "Storage devices", [Internal storage]/[SD card]

- 3 Select the folder
- 4 Select the file

Creating folders

- 1 In the home screen, [Google] ▶ [Files]
- 2 In "Storage devices", [Internal storage]/[SD card]
- 3 Move to the location to create a folder
- 4 [:] ▶ [Add new folder]

- 5 Enter a folder name ▶ [Create Folder]

Changing the name of a folder/file

- 1 In the home screen, [Google] ▶ [Files]
- 2 In "Storage devices", [Internal storage]/[SD card]
- 3 [:] for the folder/file with the name to change ▶ [Rename]
- 4 Enter the name ▶ [OK]

Deleting folders/files

- 1 In the home screen, [Google] ▶ [Files]
- 2 In "Storage devices", [Internal storage]/[SD card]
- 3 [:] for the folder/file to delete ▶ [Delete permanently]
- 4 [Delete]

Copying folders/files

- 1 In the home screen, [Google] ▶ [Files]
- 2 In "Storage devices", [Internal storage]/[SD card]
- 3 [:] for the folder/file to copy ▶ [Copy to]
- 4 [Internal storage]/[SD card]
- 5 Select the location where to copy ▶ [Copy here]

Moving folders/files

- 1 In the home screen, [Google] ▶ [Files]
- 2 In "Storage devices", [Internal storage]/[SD card]
- 3 [:] for the folder/file to move ▶ [Move to]
- 4 [Internal storage]/[SD card]
- 5 Select the location where to move ▶ [Move here]

Searching files

Use the "Files" app to search files saved in internal storage or on microSD card.

- 1 In the home screen, [Google] ▶ [Files]
- 2 [Q]
- 3 Enter search keywords ▶ [🔍]
- 4 Select the file from the search results

Data Transfer

Bluetooth® transfer

The Bluetooth function is a technology that enables wireless connection with Bluetooth devices such as PCs and handsfree headsets.

- Wireless connection with all Bluetooth devices is not completely guaranteed.
- Bluetooth version →P.90

NOTE

- The Bluetooth ON/OFF setting does not change with handset powered off.
 - You can set the Bluetooth function to OFF to reduce battery consumption.
- **Radio interference with Wi-Fi-compatible devices**
- Bluetooth devices and wireless LAN (IEEE 802.11 b/g/n) use the same frequency band (2.4 GHz). Using the handset near a wireless LAN device may cause interference, resulting in lower communication speed, noise, and poor connection. In this instance, turn off the wireless LAN device or keep the handset and the connected Bluetooth device at least 10 m away from the wireless LAN.

Using the Bluetooth function

Before connecting the handset and the Bluetooth device, pair them first.

- Once paired, pairing information is saved.
- Check on the device to be paired that the Bluetooth function is ON and that it is discoverable beforehand.

- 1 In the home screen, [⌘] ▶ [Settings] ▶ [Connected devices]
- 2 [Connection preferences] ▶ [Bluetooth]
- 3 Set "Use Bluetooth" to ON
- 4 [Pair new device]
- 5 Select a Bluetooth device ▶ [PAIR]
 - Confirmation for connection may be displayed.
 - Entering the Bluetooth pairing code (passcode) for the other Bluetooth device may be necessary. Also, some Bluetooth devices may start connection after being registered.
 - Tap "⚙️" to the right of the name of a paired Bluetooth device to change the name of the other device, etc.

NOTE

- You can connect up to 7 Bluetooth devices at the same time. Bluetooth devices may not work properly or the number of Bluetooth devices which can be connected at the same time may differ depending on the profile.
- If connecting a Bluetooth device fails, connection may be possible after re-registering it.

- When the Bluetooth function is set to ON, the handset is set to receive registration requests/connection requests from other Bluetooth devices. To search from another Bluetooth device, first display "Connected devices" in the handset settings.
- While in connection stand-by, even if a connection request from a Bluetooth device is received, connection may not be made depending on the signal conditions, etc.
- For details on operating the other Bluetooth device, refer to the manual of the Bluetooth device to be used.

When receiving a registration request from a Bluetooth device or a connection request from an unregistered Bluetooth device

- 1 Registration request/connection request from Bluetooth device
- 2 In the pairing screen, [PAIR]
 - Entering the Bluetooth pairing code (passcode) for the other Bluetooth device may be necessary.
 - Confirmation for connection may be displayed.

Unregistering Bluetooth devices

- 1 In the home screen, [⌘] ▶ [Settings] ▶ [Connected devices]
- 2 [⚙️] to the right of the name of the Bluetooth device to unregister
- 3 [FORGET] ▶ [FORGET DEVICE]

Disconnecting Bluetooth devices

- 1 In the home screen, [⌘] ▶ [Settings] ▶ [Connected devices]
- 2 [⚙️] to the right of the name of the Bluetooth device to disconnect
- 3 [DISCONNECT]

Sending/receiving via Bluetooth transfer

Sending data

Example: with photos/movies

- 1 In the home screen, [Photos]
- 2 Touch and hold the photo or movie to send in the list
- 3 [↵]
- 4 [Bluetooth]
 - If "Bluetooth" is not displayed, tap [More] ▶ [Bluetooth].
- 5 Tap the name of the Bluetooth device where to send

Receiving data

- 1 Data is sent from a sending Bluetooth device
- 2 [ACCEPT] for the notification of arriving data
 - If the notification disappears, slide the status bar down to display the notification.
- 3 Tap the "Bluetooth share" notification
 - If the notification disappears, slide the status bar down to display the notification.
- 4 Tap the received data in the "Inbound transfers" screen

NOTE

- It may not be possible to receive all data depending on the data type.
- If space where data is being saved becomes insufficient while receiving data, data received to that point is saved and receiving ends.

NFC communication

NFC stands for Near Field Communication and is a near field wireless communication system which conforms to the international standards set by ISO (International Organization for Standardization). You can use the contactless IC card function, Reader/Writer function, etc. on the handset.

- NFC/Osaifu-Keitai function settings →P.56

Connecting with External Devices

PC connection

Connecting the handset and PC

Connect the handset with a PC, etc. to recharge the handset or to transfer data in handset memory or on a microSD card.

Connecting with USB cable A to C 02 (sold separately) is described as an example.

- 1 Insert the USB Type-C connector on the USB cable A to C 02 into the handset USB Type-C connector terminal without bending
- 2 Insert the USB connector on the USB cable A to C 02 into the USB connector on the PC without bending

NOTE

- Use a USB cable compatible with the handset. A connector with a different shape cannot be used.
- Using a USB hub or adapter plug may prevent normal use.
- Do not remove the USB cable A to C 02 while exchanging data with the PC. Data may be damaged.
- Connectable PC operating systems are Windows 10 and Windows 11 (Japanese versions)

Transferring data

You can transfer data from a PC to handset memory or microSD card.

- 1 Connect the handset to a PC via a USB cable A to C 02 (sold separately)
- 2 In "Allow access to your data" screen, [ALLOW]
 - When "Allow access to your data" screen is not displayed, or to change "Use USB for", select the notification on how to use the USB connection in the notifications panel to display settings.
- 3 Transfer data
- 4 Disconnect the USB cable A to C 02 from the handset and the PC after use

International Roaming

About International Roaming (WORLD WING)

International roaming (WORLD WING) is a service which allows you to use the same phone number and email address as in Japan within the service areas of overseas providers linked with DOCOMO. This service is accessible without any changes to your phone or SMS settings.

For details on international roaming (WORLD WING), see the NTT DOCOMO website.
<https://www.docomo.ne.jp/english/service/world/roaming/>

NOTE

- For country codes, international call access numbers, and countries/regions and carriers where connection is available, see the NTT DOCOMO website.

Services available overseas

Major communications services	5G	LTE	3G	3G 850	GSM (GPRS)
Phone	×	○	○	○	○
SMS	×	○	○	○	○
Packet communication*	×	○	○	○	○

* To use packet communication while roaming, set the data roaming setting to ON. →P.80

NOTE

- Some services may be unavailable depending on the overseas carrier or network.
- The name of the connected carrier is displayed in the notifications panel (→P.34).

Before using the handset overseas

Check before departing

Check the following while in Japan before departing if you are going to use the handset overseas.

Subscription contract/charges

- Check the progress of your WORLD WING application beforehand. You may be required to make an application depending on your fee plan.
- Service charges while overseas are different than those in Japan.
- For details, see the website for your fee plan.

Charging

- For details on charging, see the NTT DOCOMO website.

Settings beforehand

Network service settings

If you are subscribed to our network service, while overseas you can also use voicemail, call forwarding, caller ID display request, and other network services. Some network services are not available.

- To use network services overseas, you are required to initiate "Remote operation settings". You can also make "Remote operation settings" from your destination. While in Japan (→P.43), while overseas (→P.82)
- Even with network services where enabling/disabling the service on the handset is possible, some services may not be available depending on the overseas carrier.

Things to check in the country of stay

After arriving in the overseas country, the handset automatically connects to an available carrier/network after it is powered on.

Connection

If "Automatically select network" is set to ON, the handset selects an optimal network automatically.

Settings for overseas use

Data roaming settings

To use packet communication overseas, you must set the data roaming setting to ON.

- In the home screen, [☰] ▶ [Settings] ▶ [Network & internet] ▶ [SIMs]
 - If using a nano SIM card and an eSIM at the same time, select the SIM to set.
- Set "Data roaming" to ON ▶ Check the confirmation and tap [OK]

Carrier settings

At time of purchase, the handset is set to automatically detect and switch to an available network. To switch to a network manually, set the network as follows.

- In the home screen, [☰] ▶ [Settings] ▶ [Network & internet] ▶ [SIMs]
 - If using a nano SIM card and an eSIM at the same time, select the SIM to set.
- Set "Automatically select network" to OFF
 - Search for and display available networks.
 - If an error occurs while searching networks, set "Mobile data" to OFF and search again (→P.63).
- Select a carrier network

NOTE

- To switch networks automatically, set "Automatically select network" to ON in step 2.

Setting the preferred network type

- 1 In the home screen, [⌘] ▶ [Settings] ▶ [Network & internet] ▶ [SIMs]
 - If using a nano SIM card and an eSIM at the same time, select the SIM to set.
- 2 [Preferred network type]
- 3 [5G/4G/3G/GSM] / [4G/3G/GSM] / [3G/GSM] / [GSM]

Date and time

If "Set time automatically" or "Set time zone automatically" are set to ON, the handset obtains and corrects its time and time difference from the overseas carrier's network.

- Correction of the time and time difference may not be made correctly depending on the overseas carrier's network. In this instance, set the time zone manually.
- When correction is made differs with each overseas carrier.
- Date and time →P.74

Inquiries

- If the handset or nano SIM card becomes lost or stolen while overseas, contact DOCOMO immediately from your location and request to have use discontinued. For where to inquire, see the last page. You can also request to have use discontinued from My docomo. Note that you are also responsible for any call and communication charges occurring after the handset is lost or stolen.
- If using a landline phone, the "international call access number" assigned to your country of stay will be required.

Making/receiving calls in your country of stay

Calling to another country (including Japan)

You can use international roaming to call from your country of stay to another country or region.

- Add a "+" at the beginning of the number, then enter the country number and phone number, to make an international call from your country of stay to Japan or another country or region.
- For details on connectable countries and carriers, see the NTT DOCOMO website.

- 1 In the home screen, [☎] ▶ [DIALPAD]
- 2 + (touch and hold [0]) ▶ Enter the country/region code (area code) then the other party's phone number
 - As for region codes (area codes) that begin with "0", omit the first "0" when entering. Some countries, such as Italy, require a first "0".
 - If the person you are calling is using "WORLD WING" overseas, enter "81" (Japan) as the country code.

3 [☎]

4 When the call ends, [📞]

Using international dial assist to make a call

To make a call from your country of stay to another country or region, use international dial assist to make an international call.

- Automatic conversion for international dial assist must be set to ON beforehand (→P.82).
 - The "0" at the beginning of a region code is automatically converted to a preset country code.
- 1 In the home screen, [☎] ▶ [DIALPAD]
 - 2 Enter the region code (area code) then the other party's phone number
 - 3 [☎]
 - If an international dial assist screen is displayed, tap "Convert number".
 - 4 When the call ends, [📞]

Calling within your country of stay

In the same way as calling from inside Japan, simply enter the number of the landline phone or mobile phone to make a call.

- 1 In the home screen, [☎] ▶ [DIALPAD]
- 2 Enter the phone number
 - If calling a landline phone, enter the region code (area code) then the other party's phone number.
- 3 [☎]
 - If an international dial assist screen is displayed, tap "Use original number".
- 4 When the call ends, [📞]

Calling a WORLD WING user overseas

If the other person is using international roaming, make the call as an international call to Japan, also in the instance of making the call within your country of stay.

- Since communication is made via Japan regardless of the country of stay, dial the number in the same way as an international call to Japan.
+ (touch and hold "0") - 81 (country code for Japan) - phone number omitting the first "0"

Receiving calls in your country of stay

You can receive calls while overseas with the same operation as when in Japan.

NOTE

- When a call arrives while you are using international roaming, the call is connected as an international call from Japan regardless of the calling country or region. Communication charges to Japan are incurred by the caller, and connection charges are incurred by the callee.

How the caller can call

■ Having them call from within Japan to your country of stay

To have someone call you from a landline phone or mobile phone within Japan to your handset in your country of stay, simply have them dial the phone number the same way they would if you were in Japan.

■ Having them call from outside Japan to your country of stay

Since they will call via Japan regardless of your country of stay, they must dial the international call access number for the country they are calling from as well as "81" (country code for Japan). international call access number for call origin country -81-90 (or 80, 70) -XXXX-XXXX

International roaming settings

Make settings for using international roaming service.

- It may not be possible to make settings with some overseas carriers.
- In the home screen, [📞] ▶ [⋮]
 - [Call settings] ▶ [Settings for network services/roaming/Extension Line service]
 - If confirmation appears, follow the instructions on the screen.
 - [Roaming settings]

Incoming call restriction while roaming	Restrict arriving calls while using international roaming.
Incoming call notification while roaming	Receive SMS notifications for calls that did not arrive while using international roaming and out of service area, etc.
Roaming guidance	Play a message for callers that you are currently using international roaming.
Network service	Network service (overseas) settings →P.82

International dial assist settings

- In the home screen, [📞] ▶ [⋮]
- [Call settings] ▶ [International dial assist]

Automatic conversion	Adds the country code automatically.
Country code	Select the country code to use with automatic conversion.

Network service (overseas) settings

Make network service settings for voicemail, etc. to use in your country of stay.

- You are required to first initiate "Remote operation settings" (→P.43).
 - Call charges from country of stay to Japan are incurred for operation from overseas.
 - It may not be possible to make settings with some overseas carriers.
- In the home screen, [📞] ▶ [⋮]
 - [Call settings] ▶ [Settings for network services/roaming/Extension Line service]
 - If confirmation appears, follow the instructions on the screen.

3 [Roaming settings] ▶ [Network service]

Remote operation (charges apply)	Enable remote operation to be initiated.
Caller ID notification request service (charges apply)	Plays guidance asking a caller not sending their number to send their number.
Incoming call notification while roaming (charges apply)	Incoming call notification while roaming (charges apply) →P.82
Roaming guidance (charges apply)	Roaming guidance (charges apply) →P.82
Voicemail service (charges apply)	Have messages from callers held when you are in a location with poor reception, handset is powered off, etc. (requires application).
Call forwarding service (charges apply)	Enable calls to be forwarded to a preregistered mobile, etc. (requires application).

4 Follow the instructions on the screen

5 Follow the audio guidance

Things to check after returning

After returning to Japan, return the handset to its settings before departure.

■ If you used packet communication overseas

- Set "Data roaming" to OFF (→P.80).

■ If the handset does not connect to the DOCOMO network automatically after returning to Japan

- Set "Preferred network type" to "5G/4G/3G/GSM" (→P.81).
- "Automatically select network" to ON (→P.80).



Appendix

Troubleshooting (FAQ)

Check here first

- You can perform a diagnosis yourself if you think the handset may be malfunctioning. For details, see the NTT DOCOMO website.
- Check if the software needs to be updated, and update it if necessary (→P.87).
- If problematic symptoms are not improved after going through the check items, feel free to contact us. For where to inquire, see the last page.



Power



Symptoms	Check Items
Handset does not power on	<ul style="list-style-type: none">• Is the battery pack installed correctly?• Is the battery depleted?
Screen does not respond, cannot power handset off	<ul style="list-style-type: none">• If the screen no longer responds or the handset cannot be powered off, you can force-shut down the handset and restart it. Long-press  (power button) and  (volume up button) at the same time for at least 11 seconds to restart it. * Note that the handset is being forced to restart, and data, settings, etc. may be lost.

Charging

Symptoms	Check Items
Cannot charge The charging lamp does not illuminate or it flashes	<ul style="list-style-type: none">• Is the battery pack installed correctly?• Is the power plug on the adapter firmly connected to an outlet or accessory socket?• Are the adapter and the handset connected properly?• If using an AC adapter (sold separately), is the connector on the AC adapter connected firmly to the handset?• If using a USB cable A to C O2 (sold separately), is the computer turned on?• If a call, data communication, or other function is performed for a long time while charging, the handset may become warm and the charging lamp may flash. In this instance, let the handset cool down and charge it again.

Handset operation

Symptoms	Check Items
Becomes hot while operating/ charging	<ul style="list-style-type: none">• The handset, battery pack, or the adapter may become hot during use, charging, or if using apps, taking video, etc. for a long period while charging, but this is normal. Continue use.
Usable battery time is short	<ul style="list-style-type: none">• Is the handset outside of the service area or displaying  (Voice service unavailable) or  (Data service unavailable) and not used for long periods? The handset searches for a signal to enable communication, and uses up more power. In places where handset communication is continuously not possible, power off the handset or place it in Airplane mode (→P.64).• Battery pack usable time depends on environment of usage and deterioration.• The battery pack is a consumable. Available time shortens with each repeated charge. Purchase a specified battery pack if usable time becomes extremely shorter than at the time of purchase even after fully charged.• Exit any apps you are not using (→P.35).• Set Wi-Fi and Bluetooth functions to OFF when not using them (→P.62, P.77).• Control battery consumption using the battery saver (→P.31).• Control battery deterioration using Battery Care mode (→P.66).• Internal battery usable time depends on environment of usage and deterioration.• The internal battery is a consumable. Available time shortens with each repeated charge. The handset can be submitted for internal battery replacement at a fee. To apply for repairs, see "Warranty and after-sales service" (→P.88).
The handset suddenly powers off/ restarts	<ul style="list-style-type: none">• Soiled terminals on the battery pack can cause a poor connection and the handset to power off. If soiled, wipe the terminals on the battery pack with a dry cotton swab.
No response when tapping the screen or pressing buttons	<ul style="list-style-type: none">• Is the handset powered off (→P.25)?

Symptoms	Check Items
Screen response is slow when tapping the screen or pressing buttons	<ul style="list-style-type: none"> This can happen such as when a large amount of data is saved on the handset, or when exchanging a large amount of data between the handset and a microSD card.
nano SIM card is not recognized	<ul style="list-style-type: none"> Is the nano SIM card inserted facing the right direction (→P.21)?
Clock is incorrect	<ul style="list-style-type: none"> The clock time may become inaccurate if the handset is powered on for a long period. Check that "Set time automatically", "Set time zone automatically", and "Use locale default" are set to ON, and power on the handset in a location with a good signal (→P.74).
Handset operation is unstable	<ul style="list-style-type: none"> An app installed after purchasing the handset may be the cause. If the symptom improves after starting the handset in safe mode, uninstalling an app you installed can improve the symptom. Safe mode is a function whereby the handset is started in a mode close to that when purchased. To restart the handset in safe mode, long-press  (power button) for at least 1 second ▶ Touch and hold "Power off" ▶ Tap [OK]. After safe mode activates, "Safe mode" appears at the lower screen left. To exit safe mode, power the handset on again. When the handset is powered off, long-press  (power button) until the screen turns on, then after the docomo logo is displayed, continue pressing  (volume down button) to activate safe mode. <ul style="list-style-type: none"> * Be sure to back up important data before using safe mode. * Some apps and widgets may not be displayed. * Safe mode is not a normal state of activation. Be sure to exit safe mode to use the handset normally.
App does not activate properly (does not activate, error frequent, etc.)	<ul style="list-style-type: none"> Are there any disabled apps? Enable a disabled app and try again (→P.66).

Calling

Symptoms	Check Items
Cannot call	Is the handset in Airplane mode (→P.64)?

Ringtone does not sound	<ul style="list-style-type: none"> Is "Ring & notification volume" set to mute (→P.67)? Is the handset in Manner mode (→P.30)? Is the handset in Airplane mode (→P.64)? Is the ringing time for voicemail service or call forwarding service set to "0 seconds" (→P.43)? Is the answer time setting for auto answering set to "0 seconds" (→P.42)? Is call rejection set (→P.44)?
Calls cannot be made (the call does not disappear even after moving to another place or calls cannot be made/received even though signal status is not bad)	<ul style="list-style-type: none"> Power on the handset again (→P.25) or install the battery pack or nano SIM card again (→P.19, P.21). Depending on the signal type, even if "inside the service area" or "[]" (indicating signal status) appears are displayed, making/receiving a call may not be possible. Move to another place and call again. Make sure a call restriction such as reject call setting is not set (→P.44). In a crowded place, heavy telephone/mail traffic may make it difficult to get a connection depending on how congested signal conditions are. In this instance, there is a busy signal. Move to another place or call again later.

Screen

Symptoms	Check Items
Display is dark	<ul style="list-style-type: none"> Is a short time set for "Screen timeout" (→P.68)? Have you changed the screen brightness with "Brightness level" (→P.68)? If "Adaptive brightness" is set to ON, the display brightness changes according to the surrounding brightness (→P.68). Is the Proximity/light sensor covered with a sticker, etc. (→P.18)?

Sound

Symptoms	Check Items
The other party's voice is not heard well or is too loud during a call	<ul style="list-style-type: none"> Have you changed "Call volume" (→P.67)? Change the "Heard effect" setting to ON to make the caller more audible (→P.43).

Mail

Symptoms	Check Items
Email is not automatically received	<ul style="list-style-type: none"> Is the docomo mail "Auto reception setting" set to OFF?



Camera

Symptoms	Check Items
Photos/videos captured with the camera are blurry	<ul style="list-style-type: none"> Check if the camera lens is foggy or dirty.

Osaifu-Keitai

Symptoms	Check Items
Cannot use Osaifu-Keitai	<ul style="list-style-type: none"> If Omakase Lock is activated, Osaifu-Keitai functions are not available regardless of the NFC/Osaifu-Keitai lock ON/OFF setting. Is NFC/Osaifu-Keitai lock ON/OFF set (→P.56)? Is the  mark on the handset held over the scanning device (→P.56)?

International roaming

Symptoms	Check Items
Cannot use the handset overseas (when  is displayed)	<ul style="list-style-type: none"> Have you made a WORLD WING application? Check the progress of your WORLD WING application.
Cannot use the handset overseas (when  is displayed)	<ul style="list-style-type: none"> Are you outside the international roaming service area, or in a location with a weak signal? To check if service is available in an area or with an overseas carrier, see the NTT DOCOMO website (→P.80). Try changing network or overseas carrier settings. Set "Preferred network type" to "5G/4G/3G/GSM" (→P.81). "Automatically select network" to ON (→P.80). Powering the handset off and back on may allow it to recover (→P.25).
Cannot use data communication overseas	<ul style="list-style-type: none"> Set "Data roaming" to ON (→P.80).
Suddenly the handset becomes unavailable during overseas use	<ul style="list-style-type: none"> Have you exceeded the approximate fee set for stopping usage? An approximate fee for stopping usage is set when you use "International Roaming Service (WORLD WING)". If you have exceeded the approximate fee set for stopping usage, pay up your account for the usage you have accumulated.

<p>The other party's phone number is not displayed/A different phone number from that of the other party is displayed/ Functions to use information saved in contacts or to use caller ID notification do not activate</p>	<ul style="list-style-type: none"> The caller ID will not be displayed on the handset even though the other party makes a call with the caller ID set to be notified if the used network or network operator does not notify. In addition, a different phone number from that of the other party may be notified depending on the used network or network operator.
--	--

Data management

Symptoms	Check Items
Cannot use data transfer	<ul style="list-style-type: none"> Are you using a USB hub? Using a USB hub may prevent normal use.
Data saved to microSD card does not appear	<ul style="list-style-type: none"> Reinstall the microSD card (→P.22).
Images do not display correctly when opened	<ul style="list-style-type: none"> An image will not display correctly (a black screen is displayed, etc.) if the image data is corrupted.

Bluetooth function

Symptoms	Check Items
Cannot connect to Bluetooth device/ cannot find after searching	<ul style="list-style-type: none"> You must first set the Bluetooth device (commercially available) so it is waiting to be registered, and then register the device on the handset. To delete a registered device and re-register it, first deregister devices on both the Bluetooth device (commercially available) and the handset, and register them again (→P.77).
Calls cannot be made from the handset with an external device such as a car navigation system or hands-free device connected	<ul style="list-style-type: none"> Making a call to a phone number may not be possible if you make multiple calls to the phone number when the other party does not answer or is outside the service area. In this instance, power off the handset and power it on again.

Error messages

Error message	Cause, what to do
Running out of storage	<ul style="list-style-type: none"> Handset storage is full. Move or delete app data.
No voice service	<ul style="list-style-type: none"> Temporarily set to OFF by the mobile carrier.
No mobile data service	
Cellular network not available	<ul style="list-style-type: none"> Check that a valid network is set.
SIM PUK is locked.	<ul style="list-style-type: none"> Displayed if you enter the wrong Personal Unblocking Key (PUK) for the nano SIM card 10 times continuously. Inquire at a DOCOMO shop or other venue.
SIM PIN is locked.	<ul style="list-style-type: none"> Displayed if the nano SIM card is locked with the Personal Unblocking Key (PUK). Enter the correct Personal Unblocking Key (PUK).
No SIM card - No service	<ul style="list-style-type: none"> Check that the nano SIM card is installed correctly.
Please enter SIM PIN.	<ul style="list-style-type: none"> Displayed when the handset is powered on and the PIN code is enabled. Enter the correct PIN code.
Wrong PIN	
Wrong password Wrong pattern	

Software update

A software update* is functionality for updating the handset's software and allowing you to use it safely and enjoyably. This includes the following items. Be sure the handset is updated with the latest software. A software update can be any of these 4 types.

* Displayed on the handset as a system update.

- Android OS version upgrade
The Android operating system, preinstalled apps and handset functions are upgraded to improve functionality, usability, quality, etc. and allow smooth, worry-free handset operation.
- Functionality addition
Preinstalled apps and handset functions are updated to improve functionality and usability and allow smooth handset operation.
- Quality improvement
Preinstalled apps and handset functions are updated to improve quality and allow smooth handset operation.
- Security patch update
A security patch is updated, where software is applied to fix a vulnerability. Applying the software allows more worry-free handset operation.

For details and time periods on software updates provided for the handset, see the NTT DOCOMO website.

Updating software

Starting an update

Perform any of the following to start an update.

- From an update notification
Select the notification in the status bar on the handset and start the update.
- From the regularly displayed screen
A confirmation sometimes appears when an update is available. Select the operation in the confirmation and proceed with the update.
- From handset settings
In the home screen, [⌘] ▶ [Settings] ▶ [System] ▶ Tap [System update] to start the update.
* If the handset does not require an update, "Your system is up to date" appears.

Update procedure

Perform an update as follows.

Follow the handset screen for instructions.

1 Download and install the update file

- Depending on the type of update, the update file may download and install automatically.
- A notification or confirmation may appear before the update file is downloaded and installed. If either appears, follow the onscreen steps to proceed with the system update.
* Guidance may appear indicating a communication fee is incurred, however, no fee is incurred for this update when the access point (APN) is set to docomo and docomo is set with priority for mobile data.

2 Restart

- Once the update is ready, a notification or confirmation appears.
Tap "Restart now" and the handset will restart. Select "Restart after 2:00" to restart the handset automatically at night.
- * Confirmation appears just before the handset restarts. To stop the handset from restarting, select "Not now" within a certain period of time.

3 Notification that the update is complete

- A screen appears once the update is complete.
- If the type of upgrade is an **Android OS** version upgrade, you should check after the update has completed that apps you have installed are updated. Not updating software may cause operation to be unstable or prevent functions from operating properly.

Important

- After software is updated, the handset cannot be returned to the previous software.
- Information unique to the handset (model, serial number, software version information, etc.) is sent to a DOCOMO server during a software update. DOCOMO does not use this information for purposes other than software updates.
- Restarting the handset for a software update is necessary. While restarting, no operation is possible, including making or receiving calls.
- While updating software allows data saved on the handset to remain as it is, it may not be possible to preserve data depending on the condition of your handset (malfunction, breakage, wetting, etc.). It is recommended that you back up important data beforehand. The range of data accessed by an app and that can be backed up differs with each app. Check with each app's provider for backing up data.
- You must have a Wi-Fi connection to update software when overseas.
- Software cannot be updated in the following instances. Try updating software again after resolving the issue.
 - During a call
 - Date/time not set correctly
 - Battery too low
 - Free space in handset storage too low
 - During international roaming
- Do not power off the handset or remove the battery pack while software is updating.
- It is recommended to download an update file in a location with a good signal and without moving location. If the signal is poor, the update may stop partway.
- Contact us if a software update fails and the handset becomes completely inoperable during the support period. For where to inquire, see the last page.
- While software updates are sometimes available for download after a support period, the customer assumes all responsibility pertaining to updating software.

Warranty & after-sales service

Warranty

- Warranty is for 1 year from date of purchase.
- The Battery Pack KY02 and Back Cover KY04 <K> are not covered by the warranty.
- Note that the specifications and appearance of the handset may change without notice (includes any accessories).
- Information registered in contacts, etc. may become altered or erased through malfunction, repair, or other handling of the handset. Be sure to keep a copy yourself of information in contacts, etc. as a precaution.

After-sales services

1. Repairs will be made free of charge within the warranty period for malfunction where the handset has been used according to the cautions given in the instruction manual. (The handset might be exchanged with a substitute handset.)
2. In the following instances, the handset might not be covered by warranty even if within the warranty period.
 - (1) Malfunction or damage due to modification (including software modification).
 - (2) Malfunction or damage due to the handset, display, or external connection terminal becoming damaged from being dropped, external pressure, etc., or malfunction or damage due to the handset's internal board becoming damaged or deformed.
 - (3) Malfunction or damage due to natural calamity such as fire, pollution, powerline surge, earthquake, lightning, wind or flood, etc.
 - (4) Malfunction or damage due to a device or consumable connected to the handset and not specified by DOCOMO.
 - (5) Malfunction, damage, or indication of exposure by the water-exposure seal due to seepage of water into the handset, or where indications of the handset being submersed or wetted are discovered, or where corrosion due to condensation, etc. is discovered.
 - (6) The handset has been repaired other than at a docomo-designated repair counter.
3. This warranty is valid only in Japan.
4. This warranty is a promise of free repair within the indicated period and conditions, and does not limit the customer's legal rights.
5. If malfunction/breakage is discovered in several locations in the handset after being accepted for servicing, the handset will be returned with all locations repaired, as product quality cannot be guaranteed when only partially repaired. Such repairs might not be covered by warranty even if within the warranty period.
6. Regardless of whether repairs were made or not, the handset has its operation verified, and might be returned updated with the latest software.

7. If repairs have been made, you can check the repair locations and repair dates on a copy of repair results handed to you when repairs are completed.

< Sold by >

NTT DOCOMO, INC.

1 1-1, Nagata-cho 2-chome, Chiyoda-ku, Tokyo

After-sales service

If you have problems with your handset

Before requesting repair, see "Check here first" in this instruction manual.

If repair is required

Handsets are accepted for repairs at docomo-designated repair counters (location or website). Note that repairs may require several days depending on the malfunction/breakage.

■ If the warranty period has expired

The handset can be repaired at cost upon request.

■ Internal battery replacement

The internal battery is a consumable, and not covered by warranty.

Depending on use, the internal battery may bulge near end of its usable life.

Replace if operating time shortens noticeably even after charging or if it bulges. Internal battery replacement is subject to repairs at cost.

■ Battery pack replacement

The battery pack is a consumable, and not covered by warranty.

Depending on use, the battery pack may bulge near end of its usable life.

Purchase and replace with a specified battery pack if operating time shortens noticeably even after charging or if it bulges.

■ Period that parts are stocked

Repair parts (for maintaining handset performance) are usually stocked for at least 4 years after end of production.

For details on servicing when requesting repairs, see the website. However, repairs might not be possible depending on the location of malfunction/breakage if repair parts are not in stock. For details, contact a docomo-designated repair counter.

IMPORTANT!

- Do not modify the handset or accessories.
 - May cause fire, injuries, or malfunction.
 - A handset that has been modified can be accepted for repairs only after receiving the customer's acknowledgment that modified components will be returned to as they were. However, the handset may be refused for repairs depending on how it has been modified. The following instances may be deemed to be modifications.
 - Stickers, etc. placed over the display or buttons
 - Ornamentation adhered to the handset with glue, etc.
 - Replacing the exterior or other component with a non-docomo-brand item, etc.
 - Malfunction or damage due to modification will be

subject to repairs at cost even if within the warranty period.

- Do not remove the nameplate sticker on the handset.

Please note that an intentionally removed or replaced nameplate sticker may prevent the handset from being accepted for repairs.
- Information such as function settings may be cleared (reset) through malfunction, repair, or other handling of the handset. In this instance, make settings again. Making settings may incur packet transmission fees.
- After the handset has been repaired, its MAC address for using Wi-Fi and its Bluetooth address may be changed regardless of the malfunction location.
- Although the handset is water-resistant, if water seeps into the interior of the handset or if moisture from humidity collects on the handset, immediately power it off, remove the battery pack, and have the handset repaired at a docomo-designated repair counter. However, repairs may not be possible depending on the condition of the handset.

Customer-created data and downloaded information

When changing handset models or having the handset repaired, data the customer has created, loaded from an external source, or downloaded may be altered or erased. DOCOMO is not responsible whatsoever. Note that DOCOMO cannot reimburse the customer for packet communication charges resulting from redownloading data. DOCOMO may replace the handset with a substitute handset in lieu of repairs at DOCOMO's discretion. In this instance, with some data excepted, such data cannot be transferred to the substitute handset.

Main specifications

Changes may occur as a result of software updates, etc. For latest information, refer to the NTT DOCOMO website.

Handset

Size		Height: approx. 163 mm Width: approx. 77 mm Height: approx. 14.8 mm
Weight		Approx. 248 g
Display	Size	Approx. 5.8 inches
	Type	TFT LCD
	Resolution (pixels width × height)	HD+ (720 × 1560)
Internal memory		RAM: 4 GB ROM: 64 GB*1
Battery capacity	Battery capacity	4270 mAh
	Rated watt-hours	16.3 Wh
Continuous stand-by time (at rest)*2, 3, 4	4G (LTE)	Approx. 480 hours
Continuous talk time*4, 5	4G (LTE)	LTE (VoLTE): Approx. 1700 minutes LTE (VoLTE (HD+)): Approx. 1510 minutes
Charging time		AC Adapter 08: approx. 140 minutes
Wireless LAN	Compatible standards	IEEE 802.11 a/b/g/n/ac-compliant (IEEE 802.11 n frequency bands: 2.4 GHz/5 GHz)*6, 7
Bluetooth	Version*8	5.3
Earphone mic jack	Terminal diameter	ø3.5 earphone jack
	Poles	4 poles
Camera	Effective pixels	Out-camera: approx. 16 million pixels In-camera: approx. 8 million pixels
	Auto answering	Savable number
Max. recordable time per 1 message		Up to 60 seconds

*1 The entire memory space cannot be allotted to saving captured videos/photos, downloaded apps and data, etc. For usable free space, see "Storage" (→P.67).

*2 Average usable time with the handset in strong signal conditions at rest.

*3 Continuous standby time depends greatly on current settings, surrounding conditions, frequency of calls, mail, camera, etc.

- *4 If functions are used frequently, actual time may be less than half.
- *5 Continuous call time depends greatly on current settings, surrounding conditions, frequency of calls, mail, camera, etc.
- *6 MIMO is unsupported.
- *7 MU-MIMO (client) is unsupported.
- *8 Depending on the characteristics and specifications of the Bluetooth device, operation may differ, or data exchange may not be possible.

Battery pack

Size	Approx. 54.4 mm × Approx. 70.9 mm × Approx. 8.55 mm
Weight	Approx. 78 g
Poles	4 poles

Certification and compliance

You can check information on the handset's particular certification and its mark of compliance (including its compliance and certification number).

- 1 In the home screen, [⌘] ▶ [Settings] ▶ [About phone] ▶ [Compliance information]

Specific Absorption Rate (SAR) Information of Mobile Phones

This model KY-51D mobile phone complies with the Japanese technical regulations and the international guidelines regarding human exposure to radio waves.

This mobile phone was designed in observance of the Japanese technical regulations regarding exposure to radio waves^(*) and the limits of exposure recommended in the international guidelines, which are equivalent to each other. The international guidelines were set out by the International Commission on Non-Ionizing Radiation Protection (ICNIRP), which is in collaboration with the World Health Organization (WHO), and the permissible limits include substantial safety margins designed to assure the safety of all persons, regardless of age and health conditions.

The technical regulations and the international guidelines set out the limits of exposure to radio waves as the Specific Absorption Rate, or SAR, which is the value of absorbed energy in any 10 grams of human tissue over a 6-minute period. The SAR limit for mobile phones is 2.0 W/kg.

The highest SAR value for this mobile phone when tested for use near the head is 0.742W/kg^(**), and that when worn on the body is 1.965W/kg^(***). There may be slight differences of the SAR values in individual product, but they all satisfy the limit. The actual value of SAR of this mobile phone while operating can be well below the indicated above. This

is due to automatic changes in the power level of the device to ensure it only uses the minimum power required to access the network.

This mobile phone can be used in positions other than against your head. By using accessories such as a belt clip holster that maintains a 0.5cm separation with no metal (parts) between it and the body, this mobile phone is certified the compliance with the Japanese technical regulations and the international guidelines.

The World Health Organization has stated that "a large number of studies have been performed over the last two decades to assess whether mobile phones pose a potential health risk. To date, no adverse health effects have been established as being caused by mobile phone use."

Please refer to the WHO website if you would like more detailed information.

<https://www.who.int/news-room/fact-sheets/detail/electromagnetic-fields-and-public-health-mobile-phones>

Please refer to the websites listed below if you would like more detailed information regarding SAR.

Ministry of Internal Affairs and Communications
Website:

<https://www.tele.soumu.go.jp/e/sys/ele/index.htm>

Association of Radio Industries and Businesses
Website:

<https://www.arib-empf.org/01denpa/denpa02-02.html>
(in Japanese only)

NTT DOCOMO, INC. Website:

<https://www.docomo.ne.jp/english/product/sar/>

- *1 The technical regulations are provided in Article 14-2 of Radio Equipment Regulations, a Ministerial Ordinance of the Radio Act.
- *2 Including other radio systems that can be simultaneously used with 5G/LTE.
- *3 Including other radio systems that can be simultaneously used with 5G/LTE.

FCC Notice

This device complies with part 15 of the FCC Rules. Operation is subject to the following two conditions: (1) This device may not cause harmful interference, and (2) this device must accept any interference received, including interference that may cause undesired operation.

Note:

This equipment has been tested and found to comply with the limits for a Class B digital device, pursuant to part 15 of the FCC Rules. These limits are designed to provide reasonable protection against harmful interference in a residential installation.

This equipment generates, uses, and can radiate radio frequency energy and, if not installed and used in accordance with the instructions, may cause harmful interference to radio communications.

However, there is no guarantee that interference will not occur in a particular installation. If this equipment does cause harmful interference to radio or television reception, which can be determined by turning the equipment off and on, the user is encouraged to try to correct the interference by one or more of the following measures:

- Reorient or relocate the receiving antenna.
- Increase the separation between the equipment and receiver.
- Connect the equipment into an outlet on circuit different from that to which the receiver is connected.
- Consult the dealer or an experienced radio/TV technician for help and for additional suggestions.

Warning

The user is cautioned that changes or modifications not expressly approved by the manufacturer could void the user's authority to operate the equipment.

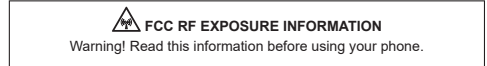

Warning! Read this information before using your phone. In August 1996, the Federal Communications Commission (FCC) of the United States, with its action in Report and Order FCC 96-326, adopted an updated safety standard for human to radio frequency electromagnetic energy emitted by FCC regulated transmitters. Those guidelines are consistent with the safety standard previously set by both U.S. and international standards bodies. The design of this phone complies with the FCC guidelines and these international standards.

Body-worn Operation

This device was tested for typical body-worn operations with the back of the phone kept 0.39 inches (1.0 cm) from the body. To comply with FCC RF exposure requirements, a minimum separation distance of 0.39 inches (1.0 cm) must be maintained between the user's body and the back of the phone, including the antenna. All beltclips, holsters and similar accessories used by this device must not contain any metallic components. Body-worn accessories that do

not meet these requirements may not comply with FCC RF exposure limits and should be avoided. This device is not intended to be used with a lanyard or strap on the body. The device contains a mounting point that may be used to attach the device to equipment, a backpack or tool belt, etc.

Turn off your phone before flying

You should turn off your phone when boarding any aircraft. To prevent possible interference with aircraft systems, U.S. Federal Aviation Administration (FAA) regulations require you to have permission from a crew member to use your phone while the plane is on the ground. To prevent any risk of interference, FCC regulations prohibit using your phone while the plane is in the air.

■ FCC Certification Information

- The product is certified by Federal Communications Commission (FCC).
The product's FCC ID is JOYEB1173.
You can view this certification in the following way.
How to confirm:
Home screen ▶ [⌘] ▶ [Settings] ▶ [About phone] ▶ [Compliance information]

Export control regulations

This product and its accessories may be subject to control by the Foreign Exchange and Foreign Trade Control Act as well as Export Administration Regulations of the US Before exporting this product and its accessories, necessary procedures must be followed at your responsibility and expense.

Intellectual property rights

Copyrights/portrait rights

Copyrighted contents you obtained by capturing them with the handset camera or from Internet websites using this product by downloading or other means, such as documents, images, music, software, are prohibited from reproduction, transformation and transmission over public lines without consent of the copyright holders, unless intended for personal use or any other purpose permitted by law.

Note that taking pictures or videos at demonstrations, performances or exhibitions may be restricted even if only for personal use. You should also refrain from taking a picture of other people with the handset and disclosing it by such means as posting it on an Internet website without their consent because of possible infringement of their right of portrait.

Trademarks

- "FOMA", "WORLD WING", "WORLD CALL", "Omakase Lock", "Osaifu-Keitai", "Public Mode", "Area Mail", "imadoco search", "Machi-Chara", "e-manual", "dmenu", "LIVE UX", "my daiz", "My Magazine", "d ACCOUNT", "Kiken desu, aruki-sumaho", "Extension Line", "My docomo", "iD" logo, "docomo phonebook" logo, "docomo Data Copy" logo are trademarks or

registered trademarks of NTT DOCOMO, INC.

- +Message is a registered trademark of NTT DOCOMO, INC., KDDI Corporation, and SoftBank Corporation.
- "キャッチホン (Call waiting service)" is a registered trademark of Nippon Telegraph and Telephone Corporation.
- Microsoft®, Windows® and Windows® 10/Windows® 11 are trademarks or registered trademarks of US Microsoft Corporation in the United States and other countries.
The official name of Microsoft® Windows® is Microsoft® Windows® Operating System.
- The Bluetooth® wordmark and logo are registered trademarks owned by Bluetooth SIG, Inc.



- Wi-Fi®, the Wi-Fi CERTIFIED logo, and Wi-Fi Direct® are registered trademarks of Wi-Fi Alliance. Wi-Fi CERTIFIED™, WPA™, WPA2™, WPA3™ are trademarks of Wi-Fi Alliance.



- The microSD logo, microSDHC logo, and microSDXC logo are trademarks of SD-3C, LLC.



- USB Type-C™ is a trademark of USB Implementers Forum.
- ℹ is a registered trademark of FeliCa Networks, Inc.
- "Google", the "Google" logo, "Android", "Google Play", the "Google Play" logo, "Gmail", the "Gmail" logo, "Google Maps", the "Google Maps" logo, "YouTube", "Google Chrome", the "Google Chrome" logo, "Google Lens", the "Google Lens" logo, "Google Cast", "Google Assistant", the "Google Voice Search" logo, "YouTube Music" logo, "Google Drive", the "Google Drive" logo, "Google Search", the "Google Search" logo, "Google Photos", the "Google Photos" logo, "Google TV", the "Files" logo, "Android Auto", and "Chromebook" are trademarks or registered trademarks of Google LLC.
- QR code is a registered trademark of Denso Wave Inc.
- ラジコ/radiko and the radiko logo are registered trademarks of radiko co., Ltd.
- FeliCa is a contactless IC card technology developed by Sony Corporation. FeliCa is a registered trademark or trademark of Sony Group Corporation or its affiliates.
- Part of this product includes modules developed by Independent JPEG Group.
- This product is covered by one or more claims of the HEVC patents listed at the URL below.
patentlist.accessadvance.com



- "wet touch" and "glove touch" are registered trademarks of Kyocera Corporation.
- Other system and product names mentioned in this manual in general are the trademarks or registered trademarks of their respective developers. The TM and ® marks are not indicated in this manual.

- All rights not indicated herein are those of their respective owners.
- The user is granted a license to use the software installed in the handset and described in this manual. Note the following when using the software.
 - (a) You must not copy, distribute, modify, analyze, reverse-engineer, or derive the source code of the software in its entirety or in part.
 - (b) You must not export the software in its entirety or in part in violation of law or regulation.
 - (c) No warranty is implied for the software's merchantability, fitness for any particular purpose, non-infringement of third-party intellectual property rights, etc. However, use of software included in the software is based on GNU General Public License (GPL), GNU Library/Lesser General Public License (LGPL) or other open-source software licenses and use of software under license to Kyocera Corporation is subject to the terms and conditions of each software license with priority.

For information on open-source software, see **■ Open-source software** as given expressly below.

■ Open-source software

This product contains open source software complying with licensing conditions of GNU General Public License (GPL), GNU Lesser General Public License (LGPL), and other open-source software. For specific conditions of GPL, LGPH, and other licensing, refer to "About phone" on this product. For details, see the Kyocera Corporation website.

This product contains software with copyrights belonging to Kyocera Corporation as well as software under license to Kyocera Corporation. Copyrights to software contained in this product and designed/developed by Kyocera Corporation in compliance with the standards and licenses of open-source software are those of Kyocera Corporation and third parties, and the customer may not distribute, copy, modify, publicly transmit, etc. the software without the consent of Kyocera Corporation, except for any scope of use as permissible by copyright law or any scope of use as permitted separately by Kyocera Corporation.

License

【OpenSSL License】

Copyright © 1998-2011 The OpenSSL Project. All rights reserved.

This product includes software developed by the OpenSSL Project for use in the OpenSSL Toolkit. (<https://www.openssl.org>)

THIS SOFTWARE IS PROVIDED BY THE OpenSSL PROJECT "AS IS" AND ANY EXPRESSED OR IMPLIED WARRANTIES, INCLUDING, BUT NOT LIMITED TO, THE IMPLIED WARRANTIES OF MERCHANTABILITY AND FITNESS FOR A PARTICULAR PURPOSE ARE DISCLAIMED. IN NO EVENT SHALL THE OpenSSL PROJECT OR ITS CONTRIBUTORS BE LIABLE FOR ANY DIRECT, INDIRECT, INCIDENTAL, SPECIAL, EXEMPLARY, OR CONSEQUENTIAL DAMAGES (INCLUDING, BUT NOT LIMITED TO, PROCUREMENT OF SUBSTITUTE GOODS OR SERVICES; LOSS OF USE, DATA, OR PROFITS; OR BUSINESS INTERRUPTION) HOWEVER CAUSED AND ON ANY THEORY OF LIABILITY, WHETHER IN CONTRACT, STRICT LIABILITY, OR TORT (INCLUDING NEGLIGENCE OR OTHERWISE) ARISING IN ANY WAY OUT OF THE USE OF THIS SOFTWARE, EVEN IF ADVISED OF THE POSSIBILITY OF SUCH DAMAGE.

【Original SSLeay License】

Copyright © 1995-1998 Eric Young (eay@cryptsoft.com) All rights reserved.

This product includes cryptographic software written by Eric Young (eay@cryptsoft.com)

THIS SOFTWARE IS PROVIDED BY ERIC YOUNG "AS IS" AND ANY EXPRESS OR IMPLIED WARRANTIES, INCLUDING, BUT NOT LIMITED TO, THE IMPLIED WARRANTIES OF MERCHANTABILITY AND FITNESS FOR A PARTICULAR PURPOSE ARE DISCLAIMED. IN NO EVENT SHALL THE AUTHOR OR CONTRIBUTORS BE LIABLE FOR ANY DIRECT, INDIRECT, INCIDENTAL, SPECIAL, EXEMPLARY, OR CONSEQUENTIAL DAMAGES (INCLUDING, BUT NOT LIMITED TO, PROCUREMENT OF SUBSTITUTE GOODS OR SERVICES; LOSS OF USE, DATA, OR PROFITS; OR BUSINESS INTERRUPTION) HOWEVER CAUSED AND ON ANY THEORY OF LIABILITY, WHETHER IN CONTRACT, STRICT LIABILITY, OR TORT (INCLUDING NEGLIGENCE OR OTHERWISE) ARISING IN ANY WAY OUT OF THE USE OF THIS SOFTWARE, EVEN IF ADVISED OF THE POSSIBILITY OF SUCH DAMAGE.

Index

Find by name

A

Accessibility	68
After-sales service	89
Airplane mode	64
Alarms	58
APN	64
App list	38

B

Barcode scanner	53
Battery	66
Battery saver	31
Battery swap	20
Bluetooth	77
Connection request	77
Disconnecting	77
Pairing	77
Passcode	77
Precautions	11
Registration request	77
Unregistering	77

C

Calculator	60
Camera	51
Camera light	18
Caring for the handset	14
Charging	24
AC adapter	25
DC adapter	25
PC	25
Charging lamp	18
Check here first	84
Clock	58
Contacts	44
Editing	45
Export	45
Favorites	45
Groups	45
Import	45
Label	45
Making a call	44
Registering	44
Copyrights	92

D

Data Saver	65
Direct keys	18, 30
Display	18, 68
docomo Data Copy	60
docomo service/cloud	73
Drag	30
Draining water	16
Dust resistance	12
dメニュー (dmenu)	55

E

Early Warning "Area Mail"	48
Checking	48
Deleting	49
Earpiece	18
Entering text	32
Copy	33
Cut	33
Flick entry	33
Paste	33
Personal dictionary	33
Settings	33
Switching entry methods	32
Toggle entry	33
Error messages	87

F

FAQ	84
FeliCa	12
Fingerprint sensor	18
Flick	29

G

Glove touch mode	68
Gmail	48
Google Lens	51
GPS	72

H

Handset settings	62
Hold	42
Home screen	36

I

In-camera	18
Initial settings	26
ACCOUNT	27
Google account	27
Intellectual property rights	92
Internal antenna areas	18
Internal Bluetooth/Wi-Fi antenna areas	18
International roaming	80

L

Light	18
Light sensor	18
Location	72
Location service	57

M

Machi-Chara	36
Mail	
+Message	46
docomo mail	46
Early Warning "Area Mail"	48
Gmail	48
Main specifications	90
Manner mode	30
Material list	9
Memo	60

Microphone	18
microSD card	22
Installing	23
Removing	23
Mobile network	63
Mouthpiece	18

N

nano SIM card	21
Installing	21
Precautions	11
Removing	22
nano SIM card/microSD card tray	18
Network & internet	62
NFC communication	78
NFC (FeliCa) antenna area	18
NFC reader/writer	12
Notification icons	34
Notification LED	33
Notifications panel	34

O

Osaifu-Keitai	55
Locking	56
Osaifu-Keitai-compatible services	56
Settings	56
Out-camera	18

P

Passwords & accounts	73
Personal Unlocking Key	28
Phone	40
Answering	41
Auto answer	42
Call histories	42
Call settings	43
Making a call	40
Operations during a call	41
Voice memo	44
Photos	54
Play Store	55
Portrait rights	92
Power	
Off	25
On	25
Power button	18
Privacy	72
Proximity sensor	18
PUK code	28

R

Radio	57
RECENTS	35

S

SAR	90
Saving a screen	31
Schedule	59
Screen lock	26
Security	69

Security codes	27
d ACCOUNT password	27
Network security code	27
Screen lock PIN/password	27
SIM PIN	27
Shock resistance	12
SIM PIN	27
Personal Unlocking Key	28
PUK code	28
Sleep mode	26
Slide	29
Software update	87
Sound & vibration	67
Speaker	18
Status bar	34
Notification icons	34
Notifications panel	34
Status icons	34
Status icons	34
Storage	67
Straphole	18
Swipe	29

T

Tap	29
Tethering	64
Touch and hold	29
Touchscreen	18
Trademarks	92
Troubleshooting	84

U

USB Type-C connector terminal	18
-------------------------------	----

V

Vibration	67
Volume down button	18
Volume up button	18
VPN	65

W

Warranty	88
Water resistance	12
Web browser	49
Wet touch	3
Wi-Fi	62
Precautions	11
Settings	63
Wi-Fi Direct	63
Working with files	76

Z

Zoom	29
------	----

記号

+Message	46
Deleting	48
Forwarding	47
Reading messages	47
Sending	46
Settings	48

Find by purpose

Basic operations

Powering on/off	25
Unlocking the screen	26
Entering Manner mode	30
Home screen layout	36
Entering text	32
Using the notifications panel	34

Phone

Making/receiving calls	40, 41
Using contacts	44
Checking phone history	42
Using auto answering	42
Using record later	44
Adjusting call volume	42
Adjusting ring and notification volume	67

Mail

Using SMS (+Message)	46
Using Gmail	48
Using docomo mail	46
Using Early Warning "Area Mail"	48

Internet

Viewing homepages	49
Using bookmarks (favorites)	50

Wi-Fi

Connecting to home or public Wi-Fi	62
--	----

Camera

Taking photos	51
Taking videos	52
Viewing taken photos/videos	52
Using the barcode scanner	53

Convenient functions

Swapping the battery pack while the handset is powered on	20
Using the notepad	60
Using a schedule	59
Using Osaiфу-Keitai	55
Using glove touch mode	68

Backup

Backing up contacts, images, etc.	60
---	----

Malfunction

Check here first	84
Where to make inquiries	H4

The handset and etiquette

Please be considerate of those around you when using the handset.

Always power off the handset in these instances

- **When in a location where use is prohibited**
For use onboard an aircraft or at a hospital, follow the instructions of the airline or facility. Power off the handset where its use is prohibited.

Set Public Mode in these instances

- **When driving**
Be careful of using the handset while driving a vehicle or riding a motorcycle/moped or bicycle. Other than where excepted by law, looking at handset screen or taking the handset in your hand to talk while driving are subject to prosecution.
- **When in a public location such as a live theater, movie theater, museum, or library**
Using the handset can create a nuisance in public places where being quiet is the norm.

Be careful of where using the handset and the volume of your voice and ringtone

- Be careful of the volume of your voice when using the handset in a quiet place such as a restaurant or hotel lobby.
- When out and around, use the handset where not a hindrance to passers-by.

Respect privacy

- When using a device with a camera to capture and send images, be sure to respect privacy.

Avoid using the handset while walking

- Looking at the screen of a smartphone or mobile phone while walking is dangerous. Your field of vision becomes extremely narrow, and can cause an accident not only for yourself but for others around you.
- When using a smartphone, stop where it is safe to use it.

These functions help keep manners in public

The handset has convenient functions such as letting you not to have to answer calls and muting the handset.

- **Manner mode (→P.30)**
Mutes the handset.
- **Public mode (power OFF) (→P.43)**
Play guidance that you are where mobiles must be powered off, and then automatically disconnect the call.
- **Handset vibration (→P.67)**
Handset vibrates to notify you of incoming calls.
- **Auto answering (→P.42)**
Records callers' messages when you cannot answer the call.
- * Additionally, optional services such as voicemail service (→P.43) and call forwarding service (→P.43) are available.



We collect your old handsets and other devices irrespective of carrier. Bring them to a docomo Shop near you.

* Collected devices: Mobile phone, PHS, battery pack, charger, desktop holder (irrespective of carrier)

Checking service charges / used data amounts / subscription details and completing procedures online

In the home screen, [dメニュー] (dmenu) ▶ My docomo
From a computer

My docomo
(<https://www.docomo.ne.jp/mydocomo/>)
(in Japanese only)

- Service may be limited by system maintenance or contract conditions.
- To use "My docomo", a "network access code" and "d ACCOUNT authentication" are required.

General Inquiries

Contact Us▶

NTT DOCOMO website

<https://www.docomo.ne.jp/support/inquiry/> (in Japanese only)



General Inquiries <docomo Information Center>

Business hours: 9:00 a.m. to 8:00 p.m. (open all year round)

Service available in: English, Portuguese, Chinese, Spanish.

■ From DOCOMO mobile phones

 (No prefix) **15770** (toll free)

* Only from a DOCOMO mobile phone or Smartphone.

■ From land-line Phones

 **0120-005-250** (toll free)

* May not be accessible from some IP phones.

■ From DOCOMO mobile phones

 (No prefix) **151** (toll free, in Japanese only)

* Only from a DOCOMO mobile phone or Smartphone.

■ From land-line Phones

 **0120-800-000** (toll free, in Japanese only)

* May not be accessible from some IP phones.

Repairs

Business hours: 24 hours (open all year round)

■ From DOCOMO mobile phones

 (No prefix) **113** (toll free, in Japanese only)

* Only from a DOCOMO mobile phone or Smartphone.

■ From land-line Phones

 **0120-800-000** (toll free, in Japanese only)

* May not be accessible from some IP phones.

- Please confirm the phone number before you dial.
- For Applications or Repairs and After-Sales Service, please contact the above-mentioned information center or check the docomo Shop etc. near you on the NTT DOCOMO website and contact.
- For online repair acceptance service, refer to DOCOMO website.

NTT DOCOMO website

<https://www.docomo.ne.jp/support/inquiry/repair/> (in Japanese only)



Corporate customer inquiries < DOCOMO Business Contact Center > (in Japanese only)

 **0120-003-300**

* Also available from mobile phones/PHS.

* May be unavailable from some IP phones.

* Not available from overseas.

Hours of service: 9:00 a.m. to 5:00 p.m. (except Saturdays, Sundays, holidays, and year-end holidays)

● Dial carefully after checking the number.

Overseas inquiries (loss / theft / calls do not connect)

■ docomo mobile phones (in Japanese only)

Display "+" on screen

-81-3-6832-6600 (toll-free)

(Touch and hold "0" for "+").

* Call can also be dialed with international call access number instead of dialing "+".

■ Landline phones (in Japanese only)

International call access number in country of stay

-81-3-6832-6600 (charges apply)

* Call charges to Japan are incurred.

* For details on international call access number, refer to the NTT DOCOMO website.

Hours of service: 24 hours (7 days a week)

- Dial carefully after checking the number.
- If the handset or nano SIM card becomes lost or stolen, immediately request to have use discontinued.
- If customer-purchased handset experiences a malfunction, bring the handset to a docomo-designated repair counter on your return.



危険です、
歩きスマホ。



キケン!
水ぬれ充電



あぶない!
電池への衝撃



Li-Ion00

Sales: NTT DOCOMO, INC.

Manufacturer: KYOCERA Corporation

'24.1 (1st edition)